

# Elpro 27

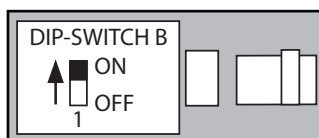

- IT** Programmatore elettronico con condensatori motore incorporati; idoneo per cancelli battenti a una o due ante, con o senza finecorsa e per cancelli scorrevoli a una o due ante (max. 0,5 CV con frizione meccanica).
- GB** Electronic control box with incorporated motor capacitors; suitable for oil-hydraulic, single or double swinging gates, with or without limit switches and for single or double sliding gates (max. 0,5 HP with mechanical clutch).
- FR** Programmateur électronique avec condensateurs moteur incorporé; adapté pour ouvre-portails a battant avec 1 ou 2 vantaux, avec ou sans fin de course et pour ouvre-portail coulissants avec 1 ou 2 vantaux (max. 0,5 CV avec embrayage mécanique).
- DE** Elektronische Steuerung mit eingebauten Motor-Kondensatoren; geeignet für ein-oder zweiflügeligen Drehtore, mit oder ohne Endschaltern und für ein-oder zweiflügeligen Schiebetore (max. 0,5 PS mit mechanischer Kupplung).

- IT** **LIBRETTO DI ISTRUZIONI**  
PER APRICANCELLI **SCORREVOLI CON FINECORSA** MONOFASE 230 V - 50/60 Hz  
**A 1 O 2 ANTE** *pag. 2-3-4-5-6-7-8*
- GB** **INSTRUCTIONS MANUAL**  
FOR **SLIDING GATE OPERATORS WITH LIMIT SWITCHES**, S-PHASE 230 V - 50/60 Hz  
**SINGLE OR DOUBLE GATES** *pages 14-15-16-17-18-19-20*
- FR** **NOTICES D'INSTRUCTIONS**  
POUR OUVRE-PORTAILS **COULISSANTS AVEC FINS DE COURSE** MONOPHASE 230 V - 50/60 Hz  
**AVEC 1 OU 2 VANTAUX** *pages 26-27-28-29-30-31-32*
- DE** **BETRIEBSANLEITUNG**  
FÜR **SCHIEBETORANTRIEBE MIT ENDSCHALTERN**, EINPHASIG 230 V - 50/60 Hz,  
**MIT EINEM ODER ZWEI TORFLÜGELN** *Seiten 38-39-40-41-42-43-44*



- IT** **LIBRETTO DI ISTRUZIONI**  
PER APRICANCELLI A **BATTENTE OLEODINAMICI** MONOFASE 230 V - 50/60 Hz  
**A 1 O 2 ANTE** *pag. 2-3-9-10-11-12-13*
- GB** **INSTRUCTIONS MANUAL**  
FOR **OIL-HYDRAULIC SWINGING ACTUATORS**, S-PHASE 230 V - 50/60 Hz  
**SINGLE OR DOUBLE GATES** *pages 14-15-21-22-23-24-25*
- FR** **NOTICES D'INSTRUCTIONS**  
POUR OUVRE-PORTAILS A **BATTANT HYDRAULIQUES** MONOPHASE 230 V - 50/60 Hz  
**AVEC 1 OU 2 VANTAUX** *pages 26-27-33-34-35-36-37*
- DE** **BETRIEBSANLEITUNG**  
FÜR **ÖLHYDRAULISCHE DREHTORANTRIEBE** EINPHASIG 230 V - 50/60 Hz,  
**MIT EINEM ODER ZWEI TORFLÜGELN** *Seiten 38-39-45-46-47-48-49*

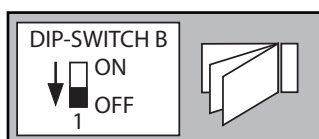

**AVVERTENZE GENERALI PER LA SICUREZZA DELLE PERSONE****GRAZIE**

Vi ringraziamo per aver deciso di acquistare un prodotto Fadini. Vi invitiamo a leggere attentamente queste istruzioni prima di iniziare a usare il dispositivo. Le istruzioni contengono informazioni importanti che vi aiuteranno a trarre il meglio da questo dispositivo e vi garantiranno altresì sicurezza in fase di installazione, uso e manutenzione del dispositivo. Conservare questo manuale in un luogo pratico, in modo da poterlo sempre consultare e garantire un utilizzo sicuro e adeguato del dispositivo.

**INTRODUZIONE**

Questa automazione è stata progettata per un utilizzo esclusivo per quanto indicato in questo libretto, con gli accessori di sicurezza e di segnalazione minimi richiesti e con i dispositivi Fadini. □ Qualsiasi altra applicazione non espressamente indicata in questo libretto potrebbe provocare disservizi o danni a cose e persone. □ Meccanica Fadini S.r.l. non è responsabile per eventuali danni derivati da usi impropri e non specificatamente indicati in questo libretto; non risponde inoltre di malfunzionamenti derivati dall'uso di materiali e/o accessori non indicati dalla ditta stessa. □ La ditta costruttrice si riserva di apportare modifiche ai propri prodotti senza preavviso. □ Tutto quanto non espressamente indicato in questo manuale di istruzioni non è permesso.

**PRIMA DELL'INSTALLAZIONE**

Prima di qualsiasi intervento valutare l'idoneità dell'ingresso da automatizzare, nonché la sua condizione e la struttura. □ Accertarsi che non si verifichino situazioni di impatto, schiacciamento, cesoiamento, convogliamento, taglio, uncinamento e sollevamento, tali da poter pregiudicare la sicurezza delle persone. □ Non installare il prodotto nelle vicinanze di fonti di calore ed evitare il contatto con sostanze infiammabili. □ Tenere lontano dalla portata di bambini qualsiasi dispositivo (trasmettitori, lettori di prossimità, selettori, ecc.) atto ad avviare l'automazione. □ Il transito nella zona di luce di passaggio deve avvenire unicamente con l'automazione ferma. □ Non consentire a bambini e/o persone di stazionare nei pressi dell'impianto con l'automazione in movimento. □ Per garantire un livello adeguato di sicurezza dell'impianto è necessario utilizzare fotocellule, bordi sensibili, spire magnetiche e sensori di presenza per mettere in sicurezza l'intera area interessata al movimento del cancello. □ Servirsi di strisce giallo-neri o di adeguati segnali per identificare i punti pericolosi dell'installazione. □ Togliere sempre l'alimentazione elettrica all'impianto se si effettuano interventi di manutenzione e/o pulizia. □ In caso di asportazione dell'attuatore, non tagliare i fili elettrici, ma toglierli dalla morsettiera allentando le viti di serraggio dentro la scatola di derivazione.

**INSTALLAZIONE**

L'intera installazione deve essere effettuata da personale tecnico qualificato, in osservanza della Direttiva Macchine 2006/42/CE e in particolare le norme EN 12445 ed EN 12453. □ Verificare la presenza, a monte dell'impianto, di un interruttore di linea 230 V - 50 Hz magneto-termico differenziale da 0,03 A. □ Utilizzare corpi di prova idonei per le prove di funzionamento nella rilevazione della presenza, in prossimità o interposti, ai dispositivi di sicurezza come fotocellule, bordi sensibili, ecc. □ Eseguire una attenta analisi dei rischi, utilizzando appositi strumenti di rilevazione di impatto e schiacciamento del bordo principale di apertura e chiusura, secondo quanto indicato nella normativa EN 12445. □ Individuare la soluzione più indicata per eliminare o ridurre tali rischi. □ Nel caso in cui il cancello da automatizzare fosse dotato di un ingresso pedonale, è opportuno predisporre l'impianto in maniera tale da interdire il funzionamento del motore quando l'ingresso pedonale è utilizzato. □ Fornire indicazioni sulla presenza dell'impianto realizzato con l'applicazione di targhe segnaletiche con marcatura CE sul cancello. □ L'installatore è tenuto ad informare ed istruire l'utilizzatore finale circa l'uso corretto dell'impianto;

ciò avviene rilasciandogli una documentazione firmata definita fascicolo tecnico, comprensiva di: schema e componenti dell'impianto, analisi dei rischi, verifica degli accessori di sicurezza, verifica delle forze di impatto e segnalazione dei rischi residui.

**INDICAZIONI PER L'UTILIZZATORE FINALE**

L'utilizzatore finale è tenuto a prendere visione e ricevere informazioni unicamente per quanto concerne il funzionamento dell'impianto e diviene lui stesso responsabile del corretto uso. □ Deve stipulare un contratto di manutenzione ordinaria e straordinaria (su chiamata) con l'installatore/manutentore. □ Qualsiasi intervento di riparazione deve essere effettuato solo da personale tecnico qualificato. □ Conservare sempre il presente manuale di istruzioni.

**AVVERTENZE PER IL BUON FUNZIONAMENTO DELL'IMPIANTO**

Per una resa ottimale dell'impianto nel tempo e secondo le normative di sicurezza, è necessario eseguire una corretta manutenzione e un adeguato monitoraggio dell'intera installazione per l'automazione, per le apparecchiature elettroniche installate e anche per i cablaggi ad esse effettuate. □ Tutta l'installazione deve essere eseguita da personale tecnico qualificato, compilando il documento di verifica e collaudo ed il registro di manutenzione indicato nel libretto normative di sicurezza (da richiedere o scaricare dal sito [www.fadini.net/supporto/downloads](http://www.fadini.net/supporto/downloads)). □ Per l'automazione è consigliato un controllo di manutenzione almeno ogni 6 mesi, mentre per apparecchiature elettroniche e sistemi di sicurezza un controllo mensile di manutenzione. □ Meccanica Fadini S.r.l. non è responsabile dell'eventuale inosservanza della buona tecnica di installazione e/o del non corretto mantenimento dell'impianto.

**SMALTIMENTO DEI MATERIALI**

Gli involucri dell'imballo come cartone, nylon, polistirolo, ecc. possono essere smaltiti effettuando la raccolta differenziata (previa verifica delle normative vigenti nel luogo dell'installazione in materia di smaltimento rifiuti). Elementi elettrici, elettronici e batterie possono contenere sostanze inquinanti: rimuovere e affidare tali componenti a ditte specializzate nel recupero dei rifiuti, come indicato nella direttiva 2012/19/UE. Vietato gettare nei rifiuti materiali nocivi per l'ambiente.

**DICHIARAZIONE DI CONFORMITÀ UE**

Fabbricante: Meccanica Fadini S.r.l.  
Indirizzo: Via Mantova, 177/A - 37053 Cerea - VR - Italy

dichiara sotto la propria responsabilità che:

Programmatore elettronico **ELPRO 27**

è conforme alla pertinente normativa di armonizzazione dell'Unione:  
- Direttiva Compatibilità Elettromagnetica 2014/30/UE  
- Direttiva Bassa Tensione 2014/35/UE

Cerea, 19/04/2017

Meccanica Fadini S.r.l.  
Direttore Responsabile



**ATTENZIONE:** prima di procedere ai collegamenti elettrici, selezionare la tipologia di automazione con il dip-switch B n° 1 e leggere le istruzioni dedicate agli apricancelli installati:  
**SCORREVOLI** da pag. 3 a pag. 8 - **BATTENTI** da pag. 9 a pag. 13.

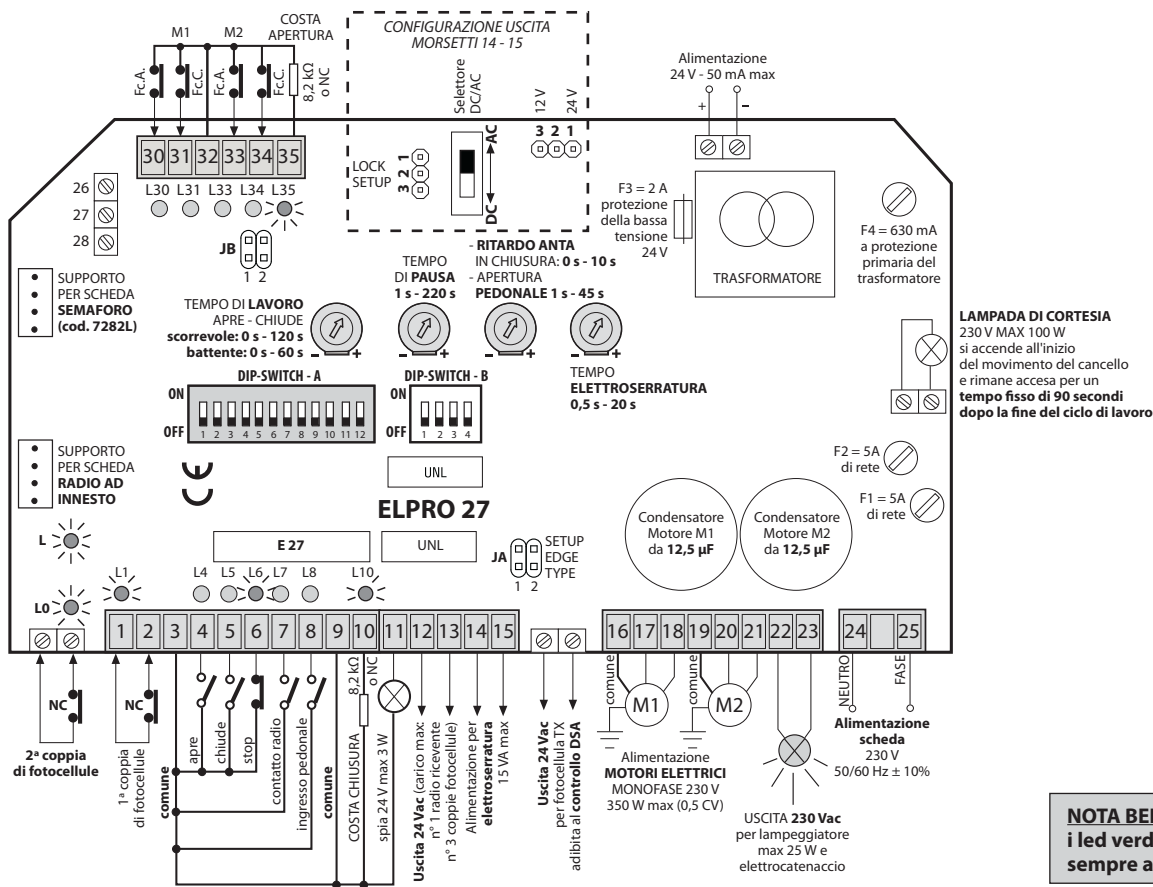

### Descrizione generale:

il programmatore elettronico **ELPRO 27** è stato realizzato come possibile soluzione per la gestione di un'automazione scorrevole con o senza finecorsa ad 1 o 2 ante, sistemi a battente a 1 o 2 ante, provvisti di valvole di regolazione forza; è alimentato a 230 V - 50/60 Hz monofase. La ditta costruttrice non si assume responsabilità circa l'uso improprio del programmatore; inoltre, si riserva il diritto di apportare in qualunque momento modifiche e aggiornamenti al programmatore.

### IMPORTANTE PER L'INSTALLAZIONE E IL CORRETTO FUNZIONAMENTO:

- Il programmatore deve essere installato in un luogo asciutto e protetto.
- Accertarsi che l'alimentazione al programmatore elettronico sia 230 V  $\pm$  10%.
- Accertarsi che l'alimentazione al motore elettrico sia 230 V  $\pm$  10%.
- Per distanze superiori ai 50 metri aumentare la sezione dei fili.
- Applicare un interruttore magneto-termico differenziale del tipo 0,03 A ad alta sensibilità all'alimentazione del programmatore.
- Per alimentazione, motore elettrico e lampeggiatore usare fili di sezione da 1,5 mm<sup>2</sup> fino a 50 m di distanza.
- Per finecorsa, fotocellule, pulsantieri e accessori usare cavi con fili da 1 mm<sup>2</sup>.
- Se non si usano le fotocellule eseguire un ponte tra i morsetti 1 e 2.
- Se non si usa nessun pulsante di stop eseguire un ponte tra i morsetti 3 e 6.
- Il trimmer del tempo di lavoro apre/chiede deve essere sempre superiore al tempo effettivo della corsa del cancello.
- N.B.: per applicazioni quali accensioni luci, telecamere, ecc. utilizzare relè statici per non creare disturbi al microprocessore.

### LED DI DIAGNOSTICA:

- L acceso** = presenza tensione di rete 230 V e integrità fusibili F1, F2, F3
- L0 acceso** = 2ª coppia fotocellule, nessun ostacolo presente
- L1 acceso** = 1ª coppia di fotocellule, nessun ostacolo presente
- L4 spento** = apre, si illumina ad impulso di comando apre
- L5 spento** = chiude, si illumina ad impulso del comando di chiusura
- L6 acceso** = blocco, si spegne ad impulso del comando di stop
- L7 spento** = radio, si illumina ad ogni impulso del trasmettitore e contatto radio
- L8 spento** = pedonale, si illumina ad ogni comando pedonale
- L10 acceso** = costa a protezione chiusura
- L30 acceso** = si spegne a Fc.A. impegnato M1
- L31 acceso** = si spegne a Fc.C. impegnato M1
- L33 acceso** = si spegne a Fc.A. impegnato M2
- L34 acceso** = si spegne a Fc.C. impegnato M2
- L35 acceso** = costa a protezione apertura

### NEL CASO DI MANCATO FUNZIONAMENTO:

- Accertarsi che l'alimentazione al programmatore elettronico sia 230 V  $\pm$  10%.
- Accertarsi che l'alimentazione al motore elettrico sia 230 V  $\pm$  10%.
- Controllare tutti i fusibili.
- Controllare che le fotocellule siano in contatto chiuso.
- Controllare che non ci sia una caduta di tensione tra il programmatore Elpro e il motore elettrico.
- Controllare tutti i contatti NC del programmatore.

### SIMBOLOGIA:

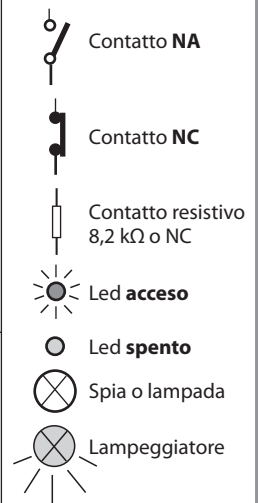

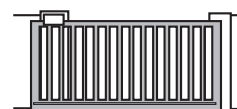
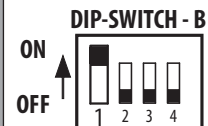

PER APRICANCELLI SCORREVOLI CON FINECORSA:  
posizionare il dip-switch - B n° 1 = ON

**Dip-switch A**

- 1 = ON Fotocellula ferma in apertura  
2 = ON Radio non inverte in apertura  
3 = ON Chiude in automatico  
4 = ON Prelampeggio attivo  
5 = ON Radio passo-passo  
6 = ON Servizio semaforo con finecorsa collegati

- 7 = OFF: libero  
8 = OFF: libero  
9 = ON Abilita ingresso 2ª coppia fotocellule  
10 = ON Lampeggiatore spento in pausa  
11 = ON Richiude in apertura e in pausa dopo passaggio su fotocellule  
12 = OFF: libero

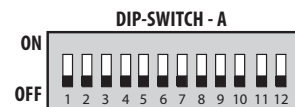
**Dip-switch B**

- 1 = ON Modalità APRICANCELLO SCORREVOLE  
2 = ON Uomo presente  
3 = ON Semaforo con "giallo" per 3 secondi  
4 = ON Controllo DSA fotocellule trasmettitori se collegati ai morsetti dedicati

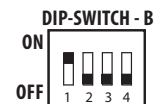

### COLLEGAMENTI ELETTRICI AI MORSETTI PER L'APERTURA SCORREVOLE - dip-switch - B n° 1 = ON

Accessorio	Collegamenti elettrici	Dip-switch e segnalazione LED delle varie funzioni
<b>2ª coppia fotocellule (installate internamente):</b> 	<p>Questa coppia di fotocellule ferma in apertura; una volta rimosso l'ostacolo il cancello continua ad aprire, nella fase di chiusura inverte la marcia.</p> <p>Con <b>dip-A n° 9 = ON</b> e collegato l'ingresso <b>NC</b>: il cancello rimane fermo in posizione bloccato per tutto il tempo che le fotocellule sono impegnate.          - In fase di apertura: a ostacolo rimosso riprende l'apertura          - In fase di chiusura: a ostacolo rimosso inverte il movimento  <b>NOTA: se non presente non è necessario ponticellare l'ingresso del contatto, lasciando solo il dip-A n° 9 = OFF</b></p>	<b>DIP-SWITCH - A N° 9:</b> <p>ON: abilita la 2ª coppia fotocellule 9 OFF: 2ª coppia fotocellule non utilizzata</p> <p> <b>L0 acceso</b> = nessun ostacolo presente, si spegne ad ostacolo presente</p>
<b>1ª coppia fotocellule (installate esternamente):</b> 	<p>Uscita <b>24 Vac</b> carico max: n° 1 radio ricevente n° 3 coppie fotocellule</p> <p>Tutti i contatti NC degli accessori di sicurezza quali fotocellule (ricevitori) devono essere collegati in serie ai morsetti 1 e 2</p>	<b>DIP-SWITCH - A N° 1:</b> <p>ON: ferma in apertura e inverte in chiusura a ostacolo rimosso 1 OFF: non ferma in apertura e inverte in chiusura in presenza di ostacolo</p> <p> <b>L1 acceso</b> = nessun ostacolo presente, si spegne ad ostacolo presente</p>
<b>Selettore a chiave:</b> 	<p>Contatti NA e NC da collegare ai rispettivi morsetti dei selettori o pulsantiere. Tutte le possibili configurazioni sono allegate ai rispettivi accessori di comando</p>	<p> <b>L4 spento</b> = nessun contatto APRE, si accende ad ogni impulso di apertura</p> <p> <b>L5 spento</b> = nessun contatto CHIUDE, si accende ad ogni impulso di chiusura</p> <p> <b>L6 acceso</b> = contatto di STOP chiuso, si spegne ad ogni impulso di stop</p>
<b>Contatto radio (con funzione passo-passo):</b> 	<p>Collegando un qualsiasi contatto NA tra i due morsetti si può ottenere ad ogni impulso:          - Solo apertura: <b>dip 2 = ON</b> e <b>dip 5 = OFF</b>          - Inversione di marcia ad ogni impulso <b>dip 2 = OFF</b> e <b>dip 5 = OFF</b>          - Passo-passo: apre-stop-chiude-stop <b>dip 2 = OFF</b> e <b>dip 5 = ON</b>          - In fase di apertura non accetta nessun comando. In pausa e in chiusura ad ogni comando esegue lo stop con inversione di marcia: <b>dip 2 = ON</b> e <b>dip 5 = ON</b></p>	<b>DIP-SWITCH - A N° 2 e N° 5:</b> <p>ON: in apertura non inverte e non blocca 2 OFF: in apertura blocca e inverte sempre</p> <p>ON: passo-passo con blocco intermedio 5 OFF: inverte il movimento ad ogni impulso radio</p> <p> <b>L7 spento</b> = nessun contatto RADIO, si accende ad ogni impulso del contatto radio</p>
<b>Uscita spia di segnalazione da 24 V max 3 W:</b>	<p>Uscita per una eventuale lampada di segnalazione 24 V max 3 W dello stato dell'automazione:          Spia <b>accesa</b> = cancello aperto          Spia <b>spenta</b> = cancello chiuso          Lampeggia <b>0,5 s (veloce)</b> = movimento di chiusura          Lampeggia <b>1 s (normale)</b> = movimento di apertura</p>	

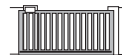

## COSTE DI SICUREZZA

I due ingressi previsti per la gestione dei bordi sensibili, sono separati per la fase di apertura e la fase di chiusura. Inoltre è possibile scegliere il tipo di contatto a loro collegato, tra quello meccanico NC e quello resistivo 8,2 kΩ tramite i due ponticelli JA1 e JA2.

Grazie alla presenza di un circuito a microcontrollore dedicato e separato a bordo della scheda, viene continuamente monitorata l'effettiva integrità e perfetta funzionalità del sistema di sicurezza. Ogni eventuale guasto o perdita di efficienza verrà segnalato tramite il lampeggio dei led L10 e L35.

## Selezione tipo di funzionamento:

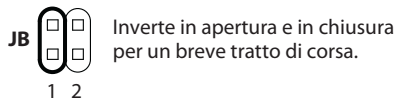

Inverte in apertura e in chiusura per un breve tratto di corsa.

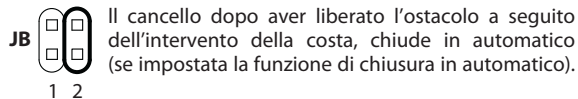



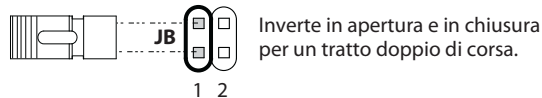

Il cancello dopo aver liberato l'ostacolo a seguito dell'intervento della costa, chiude in automatico (se impostata la funzione di chiusura in automatico).

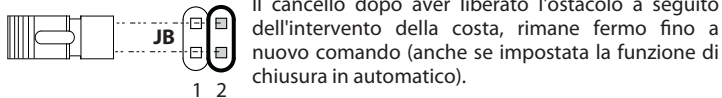

(JB1 ponticellato)

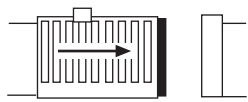
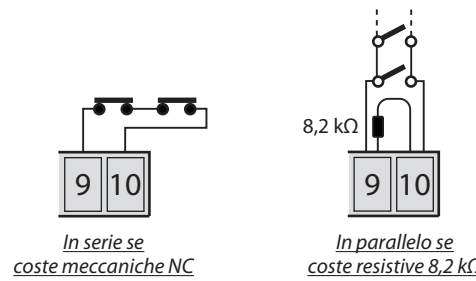
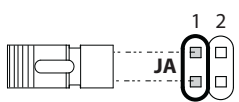

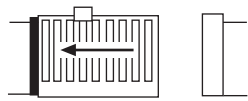
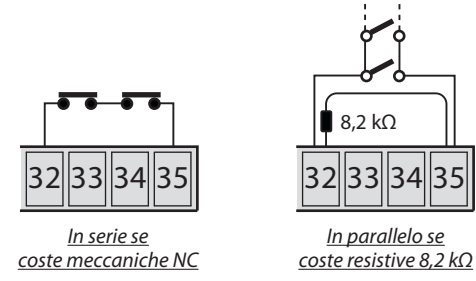
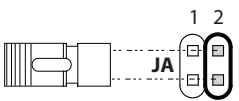
(JB2 ponticellato)

Accessorio	Collegamenti elettrici	Segnalazione LED delle varie funzioni
<p><b>Costa di sicurezza in chiusura:</b></p> 	<p><b>Collegamenti elettrici:</b></p>  <p><i>In serie se coste meccaniche NC</i></p> <p><i>In parallelo se coste resistive 8,2 kΩ</i></p> <p><b>Selezione tipo di costa utilizzata:</b></p>  <p>Costa NC (JA1 ponticellato)</p>  <p>Costa resistiva 8,2 kΩ</p>	<p><b>Segnalazione LED delle varie funzioni:</b></p>  <p><b>Normalmente acceso:</b> quando interviene la costa il led si spegne</p> <p>L10</p>
<p><b>Costa di sicurezza in apertura:</b></p> 	<p><b>Collegamenti elettrici:</b></p>  <p><i>In serie se coste meccaniche NC</i></p> <p><i>In parallelo se coste resistive 8,2 kΩ</i></p> <p><b>Selezione tipo di costa utilizzata:</b></p>  <p>Costa NC (JA1 ponticellato)</p>  <p>Costa resistiva 8,2 kΩ</p>	<p><b>Segnalazione LED delle varie funzioni:</b></p>  <p><b>Normalmente acceso:</b> quando interviene la costa il led si spegne</p> <p>L35</p>

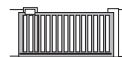



## COLLEGAMENTI ELETTRICI AI MORSETTI PER L'APERTURA SCORREVOLE - dip-switch - B n° 1 = ON

Accessorio	Collegamenti elettrici	Dip-switch e segnalazione LED delle varie funzioni
<b>Uscita 24 Vac:</b> 	<p>USCITA 24 Vac per carico max:  n° 3 coppie di fotocellule  n° 1 radio ricevente  n° 1 led selettore Chis 37 / Chis-E 37</p> <p>Tutte le istruzioni sono allegate ai rispettivi accessori di comando</p>	
<b>Elettroserratura:</b> 	<p>USCITA alimentazione 12 Vac/dc o 24 Vac/dc per <b>elettroserratura</b> 15 VA max</p> <p>"STRIP" PONTICELLO  Alimentazione elettroserratura meccanica a scatto</p> <p>LOCK SETUP  Alimentazione elettroserratura magnetica ad azione di trattenuta su battuta cancello</p> <p>AC  = uscita in corrente alternata</p> <p>DC  = uscita in corrente continua</p>	<p>TEMPO <b>ELETTROSERRATURA</b>  0,5 s - 20 s</p> <p>12 V  Alimentazione elettroserratura 12 V</p> <p>24 V  Alimentazione elettroserratura 24 V</p>
<b>Uscita per motori monofase 230 V - 350 W max - 0,5 CV:</b>	<p><b>Se presente un solo motore:</b></p> <ol style="list-style-type: none"> <li>1) Collegare l'alimentazione ai morsetti del motore M1</li> <li>2) Escludere il ritardo anta in apertura <b>dip-A n° 8 = ON</b></li> <li>3) Azzerare il trimmer di ritardo anta in chiusura al minimo</li> </ol> <p><b>Se presenti n° 2 motori:</b></p> <ol style="list-style-type: none"> <li>1) Collegare l'alimentazione ai morsetti dei motori M1 e M2</li> <li>2) Escludere il ritardo anta in apertura <b>dip-A n° 8 = ON</b></li> <li>3) Azzerare il trimmer di ritardo anta in chiusura al minimo</li> </ol>	<p>TEMPO DI <b>LAVORO</b> APRE-CHIUDE  0 s - 120 s</p> <p>TEMPO DI <b>PAUSA</b>  1 s - 220 s</p>
<b>Lampeggiatore 230 Vac:</b> 	<p>USCITA <b>230 Vac</b> per lampeggiatore max 25 W</p>	<p><b>DIP-SWITCH - A N° 4 e N° 10:</b></p> <p><input checked="" type="checkbox"/> <b>ON:</b> prelampeggio prima del movimento</p> <p><input type="checkbox"/> <b>OFF:</b> senza prelampeggio</p> <p><input checked="" type="checkbox"/> <b>ON:</b> lampeggiatore disattivato durante la pausa in funzionamento automatico (con <b>dip 3 = ON</b>)</p> <p><input type="checkbox"/> <b>OFF:</b> lampeggia durante la pausa in funzionamento automatico (con <b>dip 3 = ON</b>)</p>
<b>Alimentazione scheda 230 V:</b>	<p><b>Alimentazione programmatore</b>  230 V - 50/60 Hz ±10%</p>	



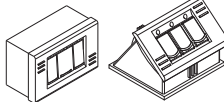
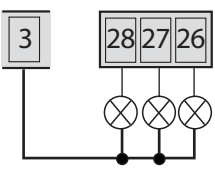

## COLLEGAMENTI ELETTRICI AI MORSETTI PER L'APERTURA SCORREVOLE - dip-switch - B n° 1 = ON

Accessorio	Collegamenti elettrici	Segnalazione LED delle varie funzioni
<b>Collegamento led Pulin 3:</b> 	 <p>Morsettiera per il collegamento dei led della pulsantiera Pulin 3</p>	
<b>Uscita 24 Vdc - 5 W:</b>	 <p>USCITA 24 Vdc - 5 W max</p>	

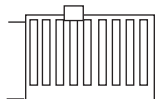



**Finecorsa per singolo scorrevole:**

Se viene utilizzato un solo motore collegare gli ingressi finecorsa in parallelo tra M1 e M2 (ponticellare 30 con 33 e 31 con 34, per poi portarli ai finecorsa apre - chiude).

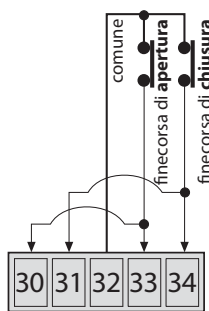
**IMPORTANTE:**

se i finecorsa **non sono utilizzati**, ponticellare gli ingressi 30 - 31 - 32 - 33 - 34. Utilizzare Fc normalmente chiusi





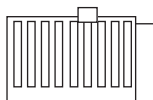
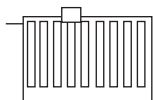

-  **L30 acceso** = si spegne a Fc apertura
-  **L31 acceso** = si spegne a Fc chiusura
-  **L33 acceso** = si spegne a Fc apertura
-  **L34 acceso** = si spegne a Fc chiusura

**Finecorsa per doppio scorrevole:**

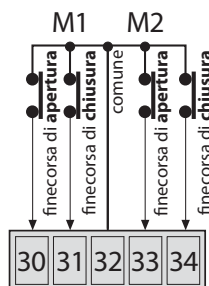
Se vengono utilizzati due motori collegare i finecorsa normalmente chiusi ai rispettivi ingressi.

**IMPORTANTE:** se i finecorsa **non sono utilizzati**, ponticellare gli ingressi 30 - 31 - 32 - 33 - 34. Utilizzare Fc normalmente chiusi



-  **L30 acceso** = si spegne a Fc apertura M1
-  **L31 acceso** = si spegne a Fc chiusura M1
-  **L33 acceso** = si spegne a Fc apertura M2
-  **L34 acceso** = si spegne a Fc chiusura M2

**Schedina semaforo ad innesto (optional - cod. 7282L):**

L'alimentazione della schedina è indipendente da quella della scheda del programmatore: 230 V - 50 Hz con uscita di 100 W a 230 V per lampada.

**Logica di funzionamento:**

- luce **VERDE** = passaggio **APERTO**
- luce **ROSSA** = passaggio **CHIUSO**
- luce **GIALLA** = interviene prima del passaggio da luce verde a luce rossa.

**Nota:** in funzionamento **pedonale** il semaforo rimane sempre **ROSSO**.

**Dip-switch - A**

- 4 = ON** Prelampeggio attivo: luce semaforo rosso - giallo - verde
- 4 = OFF** Prelampeggio disattivo: luce semaforo rosso - verde

**6 = ON** Finecorsa installati

**6 = OFF** Finecorsa ponticellati (funzionamento a tempo)

**Dip-Switch - B**

- 3 = ON** Tempo di prelampeggio prolungato di circa 2 secondi (la luce gialla arriva a 3 secondi)
- 3 = OFF** Tempo standard

**Funzionamento con 2 lampade (rossa e verde):**

- Dip-switch - A**    **4 = OFF**
- Dip-switch - A**    **6 =** adeguare la posizione a seconda della presenza o meno dei finecorsa nell'impianto

**Dip-Switch - B**    **3 = OFF**

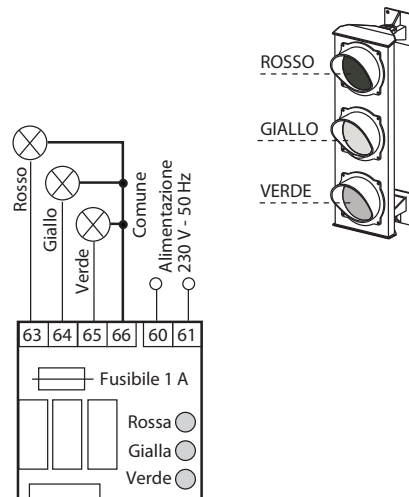

**(Optional):**  
schedina semaforo ad innesto per lampade a 230 V)  
cod. **7282L**

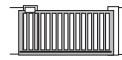

## FUNZIONI PER L'APERTURA SCORREVOLE - dip-switch - B n° 1 = ON

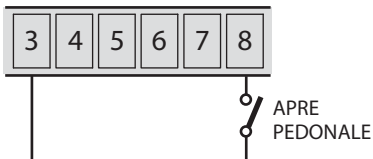
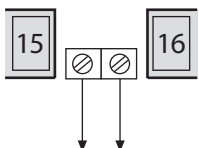
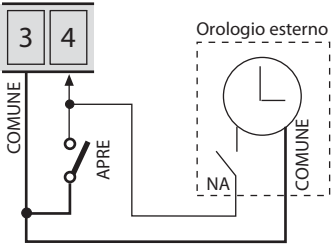
Descrizione	Dip-switch e segnalazione LED delle varie funzioni
<p><b>AUTOMATICO / SEMIAUTOMATICO:</b></p> <p><b>Ciclo automatico:</b> ad un impulso di comando apre, il cancello si apre, si ferma in pausa per il tempo impostato sul <b>trimmer pausa</b>, scaduto il quale richiude automaticamente.</p> <p><b>Ciclo semiautomatico:</b> ad un impulso di comando apre, il cancello si apre e si blocca in posizione aperto. Per chiudere il passaggio bisogna dare l'impulso di chiusura.</p>	<p><b>DIP-SWITCH - A N° 3:</b></p> <ul style="list-style-type: none"> <li><input checked="" type="checkbox"/> <b>ON:</b> chiude in automatico</li> <li><input type="checkbox"/> <b>3 OFF:</b> semiautomatico</li> </ul> <p> <b>Trimmer pausa:</b> si regola il tempo di pausa nella modalità automatico da 1 s fino a 220 s</p>
<p><b>APERTURA PEDONALE:</b></p> <p>Si ottiene l'apertura pedonale da cancello completamente chiuso tramite il comando sui contatti 3-8.</p> <p>(Si consiglia l'uso dell'apertura pedonale con dip-A n° 3 = ON per la richiusura automatica).</p> <p>La funzione <b>apertura pedonale</b> non è attiva durante il primo ciclo di funzionamento, successivo ad una mancanza di tensione di alimentazione.</p>	<p><input type="checkbox"/> <b>L8 spento</b> = nessun contatto pedonale si accende ad ogni comando pedonale</p> <p></p>
<p><b>RICHIUSURA AL PASSAGGIO SULLE FOTOCELLE:</b></p> <p><b>in fase di apertura e in pausa (con DIP-A N° 3 = ON)</b></p> <p>Funzione che permette la richiusura automatica del cancello dopo 3 s dal passaggio attraverso il fascio delle fotocelle. Per avere la richiusura automatica quando è installata la 2ª coppia di fotocelle (dip-9 = ON), è necessario attraversare il fascio di entrambe.</p>	<p><b>DIP-SWITCH - A N° 9 e N° 11:</b></p> <ul style="list-style-type: none"> <li><input checked="" type="checkbox"/> <b>ON:</b> abilita la 2ª coppia fotocelle</li> <li><input type="checkbox"/> <b>9 OFF:</b> 2ª coppia fotocelle non utilizzata</li> </ul> <ul style="list-style-type: none"> <li><input checked="" type="checkbox"/> <b>ON:</b> richiusura automatica al passaggio sulla coppia fotocelle dopo 3 secondi</li> <li><input type="checkbox"/> <b>11 OFF:</b> nessuna richiusura automatica al passaggio su fotocelle</li> </ul>
<p><b>DSA:</b></p> <p><b>CONTROLLO AUTOMATICO DELLE FOTOCELLE</b></p> <p>Per il controllo <b>DSA (Dispositivo Sicurezza Autotest)</b> bisogna collegare a questa uscita <b>le sole fotocelle trasmettitori</b> e selezionare il <b>dip-B n° 4 = ON:</b> prima di ogni movimento del cancello, se questa funzione è abilitata, Elpro 27 controlla che tutti i dispositivi fotocelle collegati siano liberi da ostacoli presenti, e correttamente funzionanti, in caso contrario il cancello non parte.</p>	<p><b>DIP-SWITCH - B N° 4:</b></p> <ul style="list-style-type: none"> <li><input checked="" type="checkbox"/> <b>ON:</b> attiva il controllo delle <b>sicurezze DSA</b></li> <li><input type="checkbox"/> <b>4 OFF:</b> disattiva controllo delle <b>sicurezze DSA</b></li> </ul> <p></p> <p>Uscita 24 Vac per fotocellula TX adibita al controllo DSA</p>
<p><b>UOMO PRESENTE:</b></p> <p>Si ottiene il comando di apertura e chiusura <i>ad azione mantenuta</i> (senza autoritenuta nei relè), quindi è richiesta la presenza dell'operatore durante tutto il movimento dell'automazione fino al rilascio del pulsante o della chiave del selettore.</p>	<p><b>DIP-SWITCH - B N° 2:</b></p> <ul style="list-style-type: none"> <li><input checked="" type="checkbox"/> <b>ON:</b> attiva funzione <i>uomo presente</i></li> <li><input type="checkbox"/> <b>2 OFF:</b> disattiva <i>uomo presente</i></li> </ul>
<p><b>PARTY FUNCTION</b></p> <p><b>APERTURA MEDIANTE OROLOGIO ESTERNO:</b></p> <p><b>Collegamento:</b> collegare il contatto NA dell'orologio ai morsetti n° 4 APRE e n° 3 COMUNE, attivando la richiusura automatica con il dip-switch n° 3 = ON.</p> <p><b>Funzionamento:</b> programmare l'orario di apertura sull'orologio, all'ora impostata il cancello si apre rimanendo aperto (il lampeggiatore si spegne), <u>e non accetterà più nessun comando</u> (anche radio) sino allo scadere del tempo impostato sull'orologio, allo scadere del quale, <u>dopo il tempo di pausa</u>, seguirà la chiusura <u>automatica</u>. Durante la sosta a cancello aperto con comando <i>orologio</i> la spia di segnalazione emette due lampeggi ravvicinati seguiti da una lunga pausa.</p>	<p><b>DIP-SWITCH - A N° 3:</b></p> <ul style="list-style-type: none"> <li><input checked="" type="checkbox"/> <b>ON:</b> chiude in automatico</li> <li><input type="checkbox"/> <b>3 OFF:</b> semiautomatico</li> </ul> <p><b>IMPORTANTE:</b> utilizzare sempre e solo con dip-A N° 3 = ON</p> <p></p>



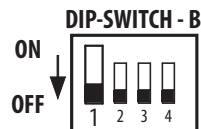

PER APRICANCELLI BATTENTI:  
posizionare il dip-switch - B n° 1 = OFF

**Dip-switch A**

- 1 = ON Fotocellula ferma in apertura  
2 = ON Radio non inverte in apertura  
3 = ON Chiude in automatico  
4 = ON Prelampeggio attivo  
5 = ON Radio passo-passo  
6 = ON Servizio semaforo con finecorsa collegati

- 7 = ON Colpo d'ariete in apertura  
8 = ON Elimina ritardo anta in apertura, i motori partono assieme  
9 = ON Abilita ingresso 2ª coppia fotocellule  
10 = ON Lampeggiatore spento in pausa  
11 = ON Richiude in apertura e in pausa dopo passaggio su fotocellule  
12 = ON Memoria tempi attiva per installazioni ad alta frequenza di lavoro

**DIP-SWITCH - A****Dip-switch B**

- 1 = OFF Modalità APRICANCELLO BATTENTE  
2 = ON Uomo presente  
3 = ON Semaforo con "giallo" per 3 secondi  
4 = ON Controllo DSA fotocellule trasmettitori se collegati ai morsetti dedicati

**DIP-SWITCH - B**

### COLLEGAMENTI ELETTRICI AI MORSETTI PER L'APERTURA A BATTENTE - dip-switch - B n° 1 = OFF

Accessorio	Collegamenti elettrici	Dip-switch e segnalazione LED delle varie funzioni
<b>2ª coppia fotocellule (installate internamente):</b> 	<p>Questa coppia di fotocellule ferma in apertura; una volta rimosso l'ostacolo il cancello continua ad aprire, nella fase di chiusura inverte la marcia.</p> <p>Con <b>dip-A n° 9 = ON</b> e collegato l'ingresso <b>NC</b>: il cancello rimane fermo in posizione bloccato per tutto il tempo che le fotocellule sono impegnate.  - In fase di apertura: a ostacolo rimosso riprende l'apertura  - In fase di chiusura: a ostacolo rimosso inverte il movimento  <b>NOTA: se non presente non è necessario ponticellare l'ingresso del contatto, lasciando solo il dip-A n° 9 = OFF</b></p>	<b>DIP-SWITCH - A N° 9:</b> <input checked="" type="checkbox"/> ON: abilita la 2ª coppia fotocellule <input type="checkbox"/> OFF: 2ª coppia fotocellule non utilizzata  <b>L0 acceso</b> = nessun ostacolo presente, si spegne ad ostacolo presente
<b>1ª coppia fotocellule (installate esternamente):</b> 	<p><b>Uscita 24 Vac</b> carico max: n° 1 radio ricevente n° 3 coppie fotocellule</p> <p>Tutti i contatti NC degli accessori di sicurezza quali fotocellule (ricevitori) devono essere collegati in serie ai morsetti 1 e 2</p>	<b>DIP-SWITCH - A N° 1:</b> <input checked="" type="checkbox"/> ON: ferma in apertura e inverte in chiusura a ostacolo rimosso <input type="checkbox"/> OFF: non ferma in apertura e inverte in chiusura in presenza di ostacolo  <b>L1 acceso</b> = nessun ostacolo presente, si spegne ad ostacolo presente
<b>Selettore a chiave:</b> 	<p>Contatti NA e NC da collegare ai rispettivi morsetti dei selettori o pulsantiere.  Tutte le possibili configurazioni sono allegate ai rispettivi accessori di comando</p>	<input type="radio"/> <b>L4 spento</b> = nessun contatto APRE, si accende ad ogni impulso di apertura <input type="radio"/> <b>L5 spento</b> = nessun contatto CHIUDE, si accende ad ogni impulso di chiusura <b>L6 acceso</b> = contatto di STOP chiuso, si spegne ad ogni impulso di stop
<b>Contatto radio (con funzione passo-passo):</b> 	<p>Collegando un qualsiasi contatto NA tra i due morsetti si può ottenere ad ogni impulso:  - Solo apertura: <b>dip 2 = ON</b> e <b>dip 5 = OFF</b>  - Inversione di marcia ad ogni impulso <b>dip 2 = OFF</b> e <b>dip 5 = OFF</b>  - Passo-passo: apre-stop-chiude-stop <b>dip 2 = OFF</b> e <b>dip 5 = ON</b>  - In fase di apertura non accetta nessun comando. In pausa e in chiusura ad ogni comando esegue lo stop con inversione di marcia: <b>dip 2 = ON</b> e <b>dip 5 = ON</b></p>	<b>DIP-SWITCH - A N° 2 e N° 5:</b> <input checked="" type="checkbox"/> ON: in apertura non inverte e non blocca <input type="checkbox"/> OFF: in apertura blocca e inverte sempre  <input checked="" type="checkbox"/> ON: passo-passo con blocco intermedio <input type="checkbox"/> OFF: inverte il movimento ad ogni impulso radio <input type="radio"/> <b>L7 spento</b> = nessun contatto RADIO, si accende ad ogni impulso del contatto radio
<b>Uscita spia di segnalazione da 24 V max 3 W:</b>	<p>Uscita per una eventuale lampada di segnalazione 24 V max 3 W dello stato dell'automazione:  Spia <b>accesa</b> = cancello aperto  Spia <b>spenta</b> = cancello chiuso  Lampeggia <b>0,5 s (veloce)</b> = movimento di chiusura  Lampeggia <b>1 s (normale)</b> = movimento di apertura</p>	

Dip-B N° 1 = OFF

PER APRICANCELLI A BATTENTE



## COSTE DI SICUREZZA

I due ingressi previsti per la gestione dei bordi sensibili, sono separati per la fase di apertura e la fase di chiusura. Inoltre è possibile scegliere il tipo di contatto a loro collegato, tra quello meccanico NC e quello resistivo 8,2 kΩ tramite i due ponticelli JA1 e JA2.

Grazie alla presenza di un circuito a microcontrollore dedicato e separato a bordo della scheda, viene continuamente monitorata l'effettiva integrità e perfetta funzionalità del sistema di sicurezza. Ogni eventuale guasto o perdita di efficienza verrà segnalato tramite il lampeggio dei led L10 e L35.



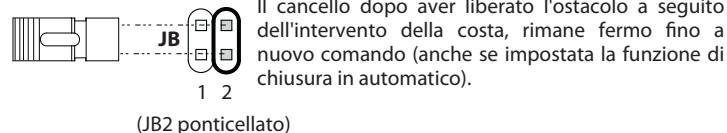
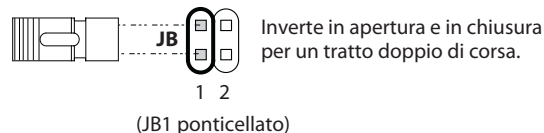
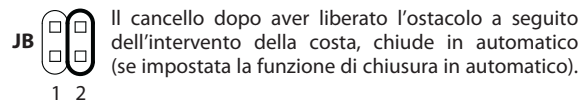
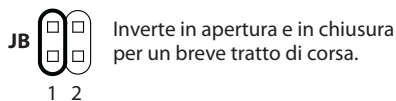







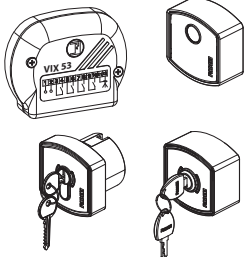
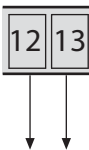
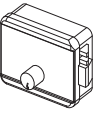

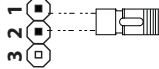
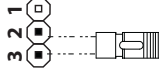
## Selezione tipo di funzionamento:

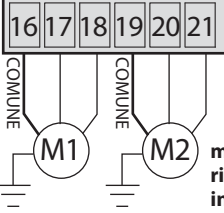

Accessorio	Collegamenti elettrici	Segnalazione LED delle varie funzioni
<p><b>Costa di sicurezza in chiusura:</b></p>	<p><i>In serie se coste meccaniche NC</i></p> <p><i>In parallelo se coste resistive 8,2 kΩ</i></p> <p><b>Selezione tipo di costa utilizzata:</b></p> <p><b>JA</b> 1 2 Costa NC (JA1 ponticellato)</p> <p><b>JA</b> 1 2 Costa resistiva 8,2 kΩ</p>	<p><b>Normalmente acceso:</b> quando interviene la costa il led si spegne</p> <p>L10</p>
<p><b>Costa di sicurezza in apertura:</b></p>	<p><i>In serie se coste meccaniche NC</i></p> <p><i>In parallelo se coste resistive 8,2 kΩ</i></p> <p><b>Selezione tipo di costa utilizzata:</b></p> <p><b>JA</b> 1 2 Costa NC (JA2 ponticellato)</p> <p><b>JA</b> 1 2 Costa resistiva 8,2 kΩ</p>	<p><b>Normalmente acceso:</b> quando interviene la costa il led si spegne</p> <p>L35</p>

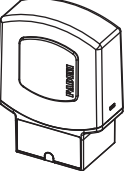

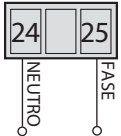



## COLLEGAMENTI ELETTRICI AI MORSETTI PER L'APERTURA A BATTENTE - dip-switch - B n° 1 = OFF

Accessorio	Collegamenti elettrici	Dip-switch e segnalazione LED delle varie funzioni
<b>Uscita 24 Vac:</b> 	 <p>USCITA 24 Vac per carico max: n° 3 coppie di fotocellule n° 1 radio ricevente n° 1 led selettore Chis 37 / Chis-E 37</p> <p>Tutte le istruzioni sono allegate ai rispettivi accessori di comando</p>	
<b>Elettroserratura:</b> 	 <p>Uscita alimentazione 12 Vac/dc o 24 Vac/dc per <b>elettroserratura</b> 15 VA max. L'elettroserratura va installata sull'anta del motore M1 ritardato in chiusura.</p> <p>"STRIP" PONTICELLO</p> <p>LOCK SETUP 3 2 1   Alimentazione elettroserratura meccanica a scatto</p> <p>LOCK SETUP 3 2 1   Alimentazione elettroserratura magnetica ad azione di trattenuta su battuta cancello</p> <p>AC   = uscita in corrente alternata</p> <p>DC   = uscita in corrente continua</p>	 TEMPO <b>ELETTROSERRATURA</b> 0,5 s - 20 s
<b>Uscita per motori monofase 230 V - 350 W max - 0,5 CV:</b>	<p><b>Se presente un solo motore:</b></p> <ol style="list-style-type: none"> <li>1) Collegare l'alimentazione ai morsetti del motore M1</li> <li>2) Escludere il ritardo anta in apertura <b>dip-A n° 8 = ON</b></li> <li>3) Azzerare il trimmer di ritardo anta in chiusura al minimo</li> </ol> <p><b>Se presenti n° 2 motori:</b></p> <p>Il ritardo anta in apertura fisso a 2 s se necessita deve essere attivo con <b>dip-A n° 8 = OFF</b></p>  <p>motore ritardato in chiusura M1 motore ritardato in apertura M2</p>	 TEMPO DI LAVORO APRE-CHIUDE 0 s - 60 s
<b>Elettrocatenaccio e lampeggiatore 230 Vac:</b> 	 <p>USCITA 230 Vac per elettrocatenaccio: è importante sempre togliere alimentazione durante la pausa con <b>dip-A n° 10 = ON</b></p> <p>USCITA 230 Vac per lampeggiatore max 25 W</p>	 TEMPO DI PAUSA 1 s - 220 s
<b>Alimentazione scheda 230 V:</b>	 <p><b>Alimentazione programmatore</b> 230 V - 50/60 Hz ± 10%</p>	 RITARDO ANTA IN CHIUSURA 0 s - 10 s
		<p><b>DIP-SWITCH - A N° 8:</b></p> <p><input type="checkbox"/> ON: elimina il ritardo anta in apertura</p> <p><input type="checkbox"/> 8 OFF: è attivo un ritardo anta di 2 s in apertura</p>
		<p><b>DIP-SWITCH - A N° 4 e N° 10:</b></p> <p><input type="checkbox"/> ON: prelampeggio prima del movimento</p> <p><input type="checkbox"/> 4 OFF: senza prelampeggio</p> <p><input type="checkbox"/> ON: lampeggiatore disattivato durante la pausa in funzionamento automatico (con <b>dip 3 = ON</b>)</p> <p><input type="checkbox"/> 10 OFF: alimentazione presente durante la pausa in funzionamento automatico (con <b>dip 3 = ON</b>)</p>

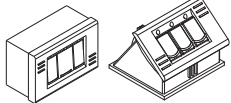
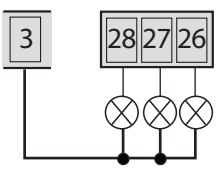

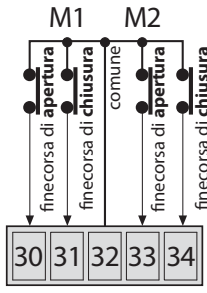
## COLLEGAMENTI ELETTRICI AI MORSETTI PER L'APERTURA A BATTENTE - dip-switch - B n° 1 = OFF

Accessorio	Collegamenti elettrici	Segnalazione LED delle varie funzioni
<b>Collegamento led Pulin 3:</b> 	 <p>Morsettiera per il collegamento dei led della pulsantiera Pulin 3</p>	
<b>Uscita 24 Vdc - 5 W:</b>	 <p>USCITA 24 Vdc - 5 W max</p>	
<b>Finecorsa:</b>	<p><b>IMPORTANTE:</b> se i finecorsa <b>non sono utilizzati</b>, ponticellare gli ingressi 30 - 31 - 32 - 33 - 34. Utilizzare Fc normalmente chiusi</p> 	 <p><b>L30 acceso</b> = si spegne a Fc apertura M1</p> <p><b>L31 acceso</b> = si spegne a Fc chiusura M1</p> <p><b>L33 acceso</b> = si spegne a Fc apertura M2</p> <p><b>L34 acceso</b> = si spegne a Fc chiusura M2</p>

**Schedina semaforo ad innesto (optional - cod. 7282L):**

L'alimentazione della schedina è indipendente da quella della scheda del programmatore:  
230 V - 50 Hz con uscita di 100 W a 230 V per lampada.

**Logica di funzionamento:**

- luce **VERDE** = passaggio **APERTO**

- luce **ROSSA** = passaggio **CHIUSO**

- luce **GIALLA** = interviene prima del passaggio da luce verde a luce rossa.

**Nota:** in funzionamento **pedonale** il semaforo rimane sempre **ROSSO**.

**Dip-switch - A**

**4 = ON** Prelampeggio attivo: luce semaforo rosso - giallo - verde

**4 = OFF** Prelampeggio disattivo: luce semaforo rosso - verde

**6 = ON** Finecorsa installati

**6 = OFF** Finecorsa ponticellati (funzionamento a tempo)

**Dip-Switch - B**

**3 = ON** Tempo di prelampeggio prolungato di circa 2 secondi  
(la luce gialla arriva a 3 secondi)

**3 = OFF** Tempo standard

**Funzionamento con 2 lampade (rossa e verde):**

**Dip-switch - A**      **4 = OFF**

**Dip-switch - A**      **6 =** adeguare la posizione a seconda della presenza o meno dei finecorsa nell'impianto

**Dip-Switch - B**      **3 = OFF**

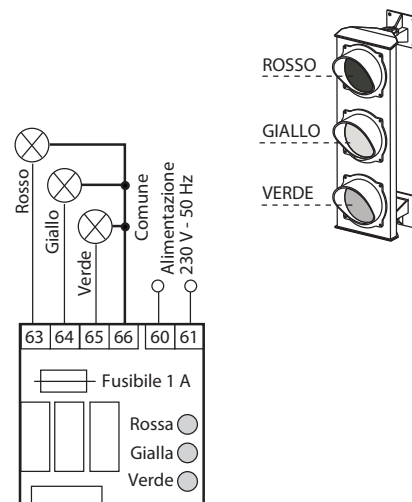
**(Optional):**

schedina semaforo ad innesto per lampade a 230 V)  
cod. **7282L**



## FUNZIONI PER L'APERTURA A BATTENTE - dip-switch - B n° 1 = OFF

Descrizione

Dip-switch e segnalazione LED delle varie funzioni

**AUTOMATICO / SEMIAUTOMATICO:**

**Ciclo automatico:** ad un impulso di comando apre, il cancello si apre, si ferma in pausa per il tempo impostato sul **trimmer pausa**, scaduto il quale richiude automaticamente.

**Ciclo semiautomatico:** ad un impulso di comando apre, il cancello si apre e si blocca in posizione aperto. Per chiudere il passaggio bisogna dare l'impulso di chiusura.

**DIP-SWITCH - A N° 3:**

- ON:** chiude in automatico
- OFF:** semiautomatico



**Trimmer pausa:** si regola il tempo di pausa nella modalità automatico da 1 s fino a 220 s

**APERTURA PEDONALE PER IL SOLO MOTORE M1:**

Si ottiene l'apertura pedonale da cancello completamente chiuso tramite il comando sui contatti 3-8.

(Si consiglia l'uso dell'apertura pedonale con dip-A n° 3 = ON per la richiusura automatica).

La funzione **apertura pedonale** non è attiva durante il primo ciclo di funzionamento, successivo ad una mancanza di tensione di alimentazione.

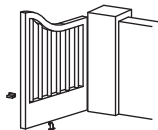

- L8 spento** = nessun contatto pedonale si accende ad ogni comando pedonale

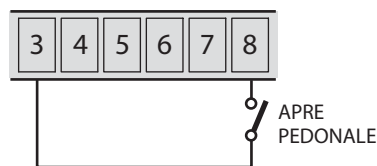
**RICHIUSURA AL PASSAGGIO SULLE FOTOCELLULE:**

**in fase di apertura e in pausa (con DIP-A N° 3 = ON)**

Funzione che permette la richiusura automatica del cancello dopo 3 s dal passaggio attraverso il fascio delle fotocellule. Per avere la richiusura automatica quando è installata la 2ª coppia di fotocellule (dip-9 = ON), è necessario attraversare il fascio di entrambe.

**DIP-SWITCH - A N° 9 e N° 11:**

- ON:** abilita la 2ª coppia fotocellule
- OFF:** 2ª coppia fotocellule non utilizzata

- ON:** richiusura automatica al passaggio sulla coppia fotocellule dopo 3 secondi
- OFF:** nessuna richiusura automatica al passaggio su fotocellule

**DSA: CONTROLLO AUTOMATICO DELLE FOTOCELLULE**

Per il controllo **DSA (Dispositivo Sicurezza Autotest)** bisogna collegare a questa uscita **le sole fotocellule trasmettitori** e selezionare il **dip-B n° 4 = ON**: prima di ogni movimento del cancello, se questa funzione è abilitata, Elpro 27 controlla che tutti i dispositivi fotocellule collegati siano liberi da ostacoli presenti, e correttamente funzionanti, in caso contrario il cancello non parte.

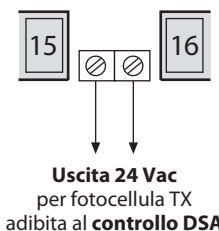
**DIP-SWITCH - B N° 4:**

- ON:** attiva il controllo delle **sicurezze DSA**
- OFF:** disattiva controllo delle **sicurezze DSA**

**UOMO PRESENTE:**

Si ottiene il comando di apertura e chiusura **ad azione mantenuta** (senza autoritenuta nei relè), quindi è richiesta la presenza dell'operatore durante tutto il movimento dell'automazione fino al rilascio del pulsante o della chiave del selettore.

**DIP-SWITCH - B N° 2:**

- ON:** attiva funzione **uomo presente**
- OFF:** disattiva **uomo presente**

**COLPO D'ARIE IN APERTURA:**

Funzione che permette di facilitare il disimpegno dell'elettroserratura a cancello completamente chiuso, anche in modalità **apertura pedonale**: le ante del cancello chiuso, prima di aprire vengono spinte in chiusura per **2 secondi**.

**DIP-SWITCH - A N° 7:**

- ON:** abilita il colpo d'ariete in apertura per 2 s
- OFF:** disabilita la funzione colpo d'ariete

**UTILIZZO CONDOMINIALE:**

Funzione per utilizzi altamente intensivi con frequenti inversioni di marcia: questa funzione abilitata tiene conto del tempo rimanente di lavoro quando c'è una inversione di marcia o un passaggio sulle fotocellule.

**DIP-SWITCH - A N° 12:**

- ON:** memoria dei tempi di lavoro attiva
- OFF:** funzionamento normale senza memoria

**PARTY FUNCTION****APERTURA MEDIANTE OROLOGIO ESTERNO:**

**Collegamento:** collegare il contatto NA dell'orologio ai morsetti n° 4 APRE e n° 3 COMUNE, attivando la richiusura automatica con il dip-switch n° 3 = ON.

**Funzionamento:** programmare l'orario di apertura sull'orologio, all'ora impostata il cancello si apre rimanendo aperto (il lampeggiatore si spegne), e **non accetterà più nessun comando** (anche radio) sino allo scadere del tempo impostato sull'orologio, allo scadere del quale, **dopo il tempo di pausa, seguirà la chiusura automatica**. Durante la sosta a cancello aperto con comando **orologio** la spia di segnalazione emette due lampeggi ravvicinati seguiti da una lunga pausa.

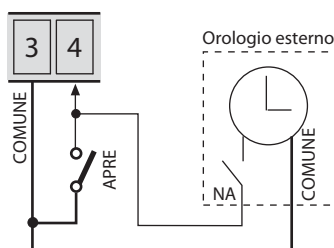
**DIP-SWITCH - A N° 3:**

- ON:** chiude in automatico
- OFF:** semiautomatico

**IMPORTANTE:**  
**utilizzare sempre e solo con dip-A N° 3 = ON**



**GENERAL WARNINGS FOR PEOPLE SAFETY****THANK YOU**

Thank you for purchasing a Fadini product. Please read these instructions carefully before using this appliance. The instructions contain important information which will help you get the best out of the appliance and ensure safe and proper installation, use and maintenance. Keep this manual in a convenient place so that you can always refer to it for the safe and proper use of the appliance.

**INTRODUCTION**

This operator is designed for a specific scope of applications as indicated in this manual, including safety, control and signaling accessories as minimum required with Fadini equipment. □ Any applications not explicitly included in this manual may cause operation problems or damages to properties and people. □ Meccanica Fadini S.r.l. is not liable for damages caused by the incorrect use of the equipment, or for applications not included in this manual or for malfunctioning resulting from the use of materials or accessories not recommended by the manufacturer. □ The manufacturer reserves the right to make changes to its products without prior notice. □ All that is not explicitly indicated in this manual is to be considered not allowed.

**BEFORE INSTALLATION**

Before commencing operator installation assess the suitability of the access, its general condition and the structure. □ Make sure that there is no risk of impact, crushing, shearing, conveying, cutting, entangling and lifting situations, which may prejudice people safety. □ Do not install near any source of heat and avoid contacts with flammable substances. □ Keep all the accessories able to turn on the operator (transmitters, proximity readers, key-switches, etc) out of the reach of the children. □ Transit through the access only with stationary operator. □ Do not allow children and/or people to stand in the proximity of a working operator. □ To ensure safety in the whole movement area of a gate it is advisable to install photocells, sensitive edges, magnetic loops and detectors. □ Use yellow-black strips or proper signals to identify dangerous spots. □ Before cleaning and maintenance operations, disconnect the appliance from the mains by switching off the master switch. □ If removing the actuator, do not cut the electric wires, but disconnect them from the terminal box by loosening the screws inside the junction box.

**INSTALLATION**

All installation operations must be performed by a qualified technician, in observance of the Machinery Directive 2006/42/CE and safety regulations EN 12453 - EN 12445. □ Verify the presence of a thermal-magnetic circuit breaker 0,03 A - 230 V - 50 Hz upstream the installation. □ Use appropriate objects to test the correct functionality of the safety accessories, such as photocells, sensitive edges, etc. □ Carry out a risk analysis by means of appropriate instruments measuring the crushing and impact force of the main opening and closing edge in compliance with EN 12445. □ Identify the appropriate solution necessary to eliminate and reduce such risks. □ In case where the gate to automate is equipped with a pedestrian entrance, it is appropriate to prepare the system in such a way to prohibit the operation of the engine when the pedestrian entrance is used. □ Apply safety nameplates with CE marking on the gate warning about the presence of an automated installation. □ The installer must inform and instruct the end user about the proper use of the system by releasing him a technical dossier, including: layout and components of the installation, risk analysis, verification of safety accessories, verification of impact forces and reporting of residual risks.

**INFORMATION FOR END-USERS**

The end-user is required to read carefully and to receive information concerning only the operation of the installation so that he becomes himself responsible for the correct use of it. □ The end-user shall establish a written maintenance contract with the installer/maintenance technician (on -call). □ Any maintenance operation must be done by qualified technicians. □ Keep these instructions carefully.

**WARNINGS FOR THE CORRECT OPERATION OF THE INSTALLATION**

For optimum performance of system over time according to safety regulations, it is necessary to perform proper maintenance and monitoring of the entire installation: the automation, the electronic equipment and the cables connected to these. □ The entire installation must be carried out by qualified technical personnel, filling in the Maintenance Manual indicated in the Safety Regulation Book (to be requested or downloaded from the site [www.fadini.net/supporto/downloads](http://www.fadini.net/supporto/downloads)). □ Operator: maintenance inspection at least every 6 months, while for the electronic equipment and safety systems an inspection at least once every month is required. □ The manufacturer, Meccanica Fadini S.r.l., is not responsible for non-observance of good installation practice and incorrect maintenance of the installation.

**DISPOSAL OF MATERIALS**

Dispose properly of the packaging materials such as cardboard, nylon, polystyrene etc. through specializing companies (after verification of the regulations in force at the place of installation in the field of waste disposal). Disposal of electrical and electronic materials: to remove and dispose through specializing companies, as per Directive 2012/19/UE. Disposal of substances hazardous for the environment is prohibited.

**UE DECLARATION OF CONFORMITY (DoC)**

Manufacturer: Meccanica Fadini S.r.l.  
Address: Via Mantova, 177/A - 37053 Cerea - VR - Italy

declare that the DoC is issued under our sole responsibility and belongs to the following product:

Control unit model **ELPRO 27**

is in conformity with the relevant Union harmonisation legislation:  
- Electromagnetic Compatibility Directive 2014/30/UE  
- Low Voltage Directive 2014/35/UE

Cerea, 19/04/2017

Meccanica Fadini S.r.l.  
Responsible Manager





**ATTENTION: before starting the electrical connections, select the mode of operation depending on gate type by dip-switch B n° 1 and read the instructions respectively dedicated as follows:**

**SLIDING gates from page 15 to page 20 - SWINGING gates from page 21 to page 25.**

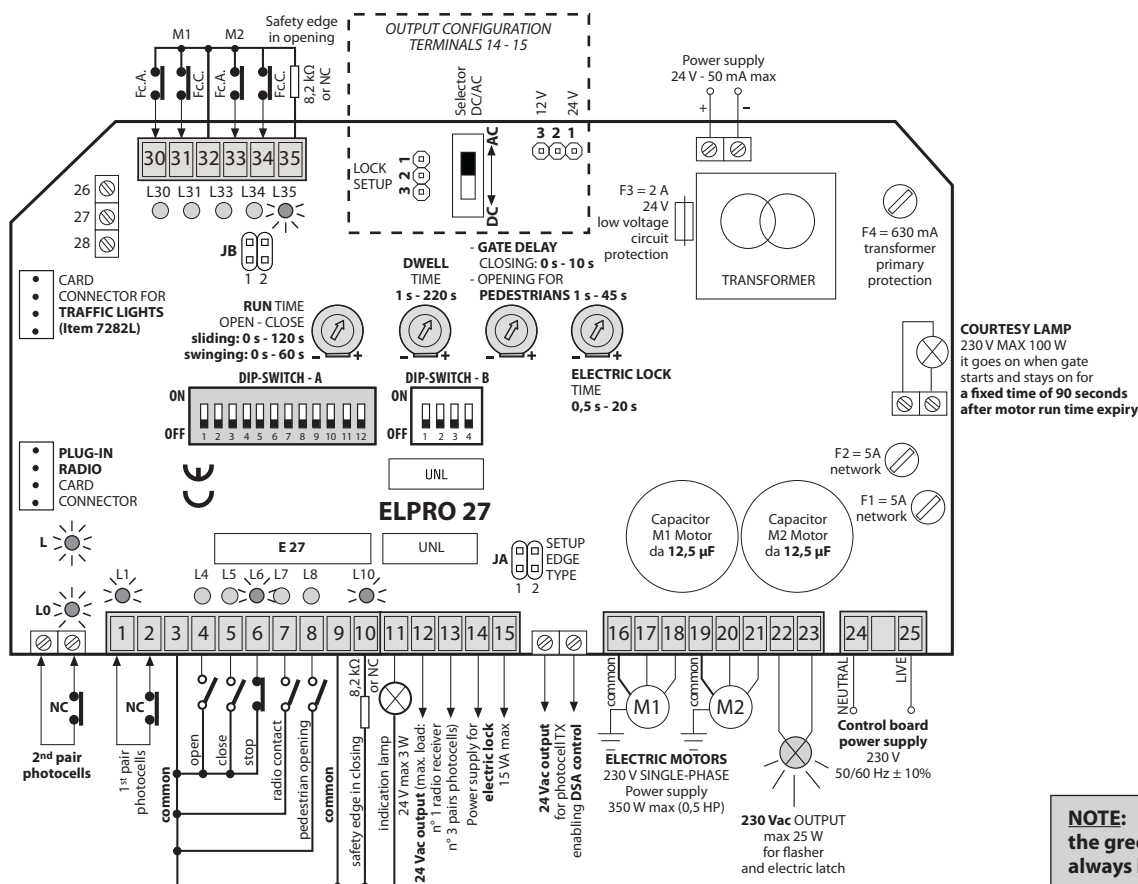

#### General description:

the electronic control box **ELPRO 27** has been developed to provide a reliable unit to control single or double sliding gate automatic systems with or without limit switches, as well as single or double swinging gate systems fitted with pressure valves; single-phase 230 V - 50/60 Hz. The manufacturer is not liable for any incorrect use of this appliance; and also reserves the right to change and update it without previous notice.

#### IMPORTANT FOR THE INSTALLATION AND THE CORRECT FUNCTIONING:

- The control box must be installed in a dry and sheltered place.
  - Make sure that power supply to the control board be 230 V  $\pm$  10%.
  - Make sure that power supply to the electric motor be 230 V  $\pm$  10%.
  - For distances longer than 50 metres increase the section of the wires.
  - Fit the mains to the control box with a high sensitivity, 0,03 A, differential, magnetic-thermal circuit breaker.
  - Cables with 1,5 mm<sup>2</sup> section wires are to be used for the power supply, electric motor and flasher for distances up to 50 m.
  - Cables with 1 mm<sup>2</sup> section wires are to be used for the limit switches, photocells, push buttons and accessories.
  - If no photocells are used link out terminals 1 and 2.
  - If no stop button is used link out terminals 3 and 6.
  - Open/close motor run time trimmer must be always superior to the time actually required for the gate travel.
- N.W.: For applications such as light switching, CCTV, etc. use solid state relays to prevent the microprocessor from being affected.

#### Diagnostic LEDs:

- L ON** = Board on 230 V voltage and F1, F2, F3 fuses all right
- L0 ON** = 2<sup>nd</sup> pair photocells, not obstructed
- L1 ON** = 1<sup>st</sup> pair photocells not obstructed
- L4 OFF** = open, it switches on by any open pulse
- L5 OFF** = close, it switches on by any close pulse
- L6 ON** = stop, it switches off by any stop pulse
- L7 OFF** = radio, it switches on by any pulse from the transmitter/radio contact
- L8 OFF** = pedestrian mode, it switches on by any pedestrian pulsing
- L10 ON** = safety edge protecting closing
- L30 ON** = it switches off when Fc.A. (limit switch Opening = L-sw.O) is engaged, M1
- L31 ON** = it switches off when Fc.C. (limit switch Closing = L-sw.C) is engaged, M1
- L33 ON** = it switches off when Fc.A. (limit switch Opening = L-sw.O) is engaged, M2
- L34 ON** = it switches off when Fc.C. (limit switch Closing = L-sw.C) is engaged, M2
- L35 ON** = safety edge protecting opening

#### IN CASE OF FAILURE PLEASE MAKE SURE THAT:

- Power supply to the electronic control box is 230 V  $\pm$  10%.
- Power supply to the electric motor is 230 V  $\pm$  10%.
- All of the fuses is all right.
- The photocell contacts are closed.
- No voltage drop has occurred from the Elpro board to the electric motor.
- All of the NC contacts of the control board are all right.

#### SYMBOLS:

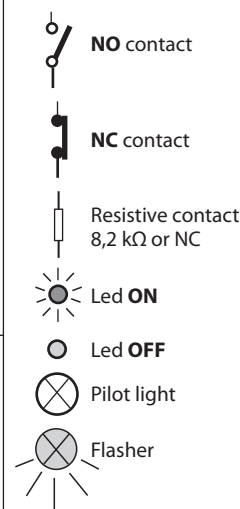

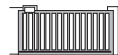
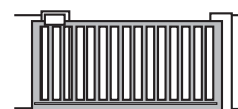
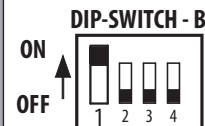
FOR SLIDING GATE AUTOMATIC SYSTEMS WITH LIMIT SWITCHES:  
dip-switch - B n° 1 = ON**Dip-switch A**

- 1 = ON Photocells stop gate in opening  
2 = ON Radio, no reversing in opening  
3 = ON Automatic closing  
4 = ON Pre-flashing in service  
5 = ON Radio step-by-step  
6 = ON Traffic lights mode limit switches connected

- 7 = OFF: blank  
8 = OFF: blank  
9 = ON 2<sup>nd</sup> pair photocells in service  
10 = ON Flasher off in dwell time  
11 = ON Gate re-closing in opening and dwell on photocells engaging  
12 = OFF: blank

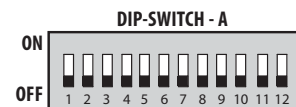
**Dip-switch B**

- 1 = ON SLIDING GATE mode  
2 = ON Hold-on-switched control mode (deadman control)  
3 = ON Traffic lights on "yellow" for 3 seconds  
4 = ON DSA control by photocell transmitters if connected to the dedicated terminals



## ELECTRICAL CONNECTIONS ON SLIDING GATE MODE - dip-switch - B n° 1 = ON

Accessory	Electrical connections	Dip-Switch setting and LED indication of functions
<b>2<sup>nd</sup> pair photocells</b> (fitted inside perimeter):  	<p>This pair of photocells stops gate in opening; once cleared from obstacle, gate goes on opening, gate travel is reversed in closing.</p> <p><b>Dip-A n° 9 = ON and the NC contact connected:</b> the gates stay stopped as long as the photocells are obstructed. - In opening cycle: obstacle removed, gates go on opening - In closing cycle: obstacle removed, gate travel reversed <b>NOTE: if no 2<sup>nd</sup> pair photocells are used, it is not necessary to bridge the contact input, only dip-A n° 9 = OFF</b></p>	<p><b>DIP-SWITCH - A N° 9:</b></p> <p><input checked="" type="checkbox"/> ON: Photocells 2<sup>nd</sup> pair in service <input type="checkbox"/> OFF: Photocells 2<sup>nd</sup> pair not installed</p> <p> <b>L0 ON</b> = no obstacle detected, it goes off in case of obstacle</p>
<b>1<sup>st</sup> pair photocells</b> (fitted outside perimeter):  	<p><b>24 Vac output</b> max load: n° 1 radio receiver n° 3 pairs photocells</p> <p>All of the NC contacts of the safety accessories such as the photocells (receivers) are to be series connected to terminals 1 and 2</p>	<p><b>DIP-SWITCH - A N° 1:</b></p> <p><input checked="" type="checkbox"/> ON: gate is stopped in opening and reversed in closing once cleared from obstacle <input type="checkbox"/> OFF: gate is not stopped in opening and is reversed in closing in case of obstacle</p> <p> <b>L1 ON</b> = no obstacle detected, it goes off in case of obstacle</p>
<b>Key-switch:</b>  	<p>NO and NC contacts to be connected to the respective terminals in the key- or button-switches. All of the possible setting combinations are described in the instructions sheets included with the respective control accessories</p>	<p><input type="checkbox"/> <b>L4 OFF</b> = no OPENING contact, it goes on whenever an opening pulse is given</p> <p><input type="checkbox"/> <b>L5 OFF</b> = no CLOSING contact, it goes on whenever a closing pulse is given</p> <p> <b>L6 ON</b> = STOP contact closed, it goes off whenever a stop pulse is given</p>
<b>Radio contact</b> (step by step mode):  	<p>Any NO connection to these two terminals will perform the following: - Opening only: <b>dip 2 = ON</b> and <b>dip 5 = OFF</b> - Gate travel reversing by any pulse <b>dip 2 = OFF</b> and <b>dip 5 = OFF</b> - Step by step: open-stop-close-stop <b>dip 2 = OFF</b> and <b>dip 5 = ON</b> - No new pulse is accepted in opening. In Dwell phase and in closing any new pulse stops and reverses gate travel: <b>dip 2 = ON</b> and <b>dip 5 = ON</b></p>	<p><b>DIP-SWITCH - A N° 2 and N° 5:</b></p> <p><input checked="" type="checkbox"/> ON: it does not stop and reverse gate travel in opening <input type="checkbox"/> OFF: always stops &amp; reverses in opening</p> <p><input checked="" type="checkbox"/> ON: step by step with intermediate stop <input type="checkbox"/> OFF: gate travel reversed by any radio pulse</p> <p><input type="checkbox"/> <b>L7 OFF</b> = no RADIO contact, it goes on by any radio pulse</p>
<b>Indication lamp output</b> <b>24 V max 3 W:</b>	<p>Output for a 24 V max 3 W indication lamp showing the status of the system: Lamp ON = gate open Lamp OFF = gate closed <b>0,5 s (fast) flashing</b> = gate closing <b>1 s (normal) flashing</b> = gate opening</p>	



## SAFETY EDGES

The two inputs, that are fitted to control the safety edges, are separated for the opening and closing phases. Also, it is possible to select the type of contact connected to them, either NC mechanical or 8,2 k $\Omega$  resistive, by means of the two jumpers JA1 or JA2. Thanks to a dedicated microcontroller circuit separately fitted on to the board, the actual integrity and correct functioning of the safety system is constantly controlled. Any possible fault or loss of efficiency is signalled by the L10 and L35 LEDs keeping flashing.



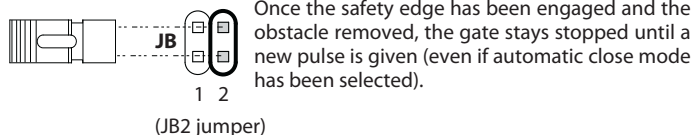
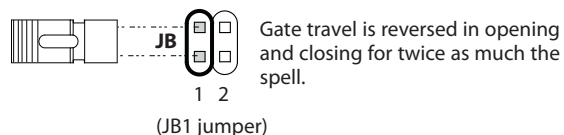
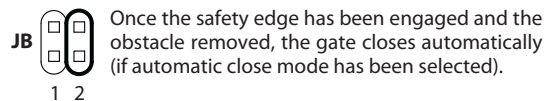
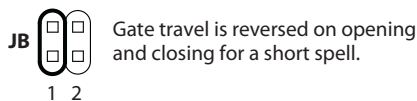



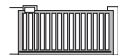



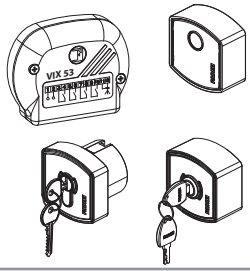

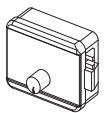

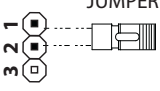
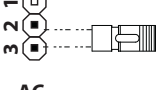

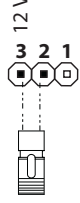
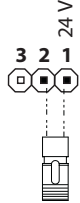
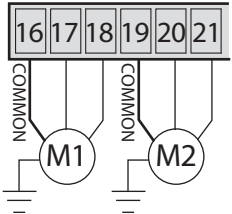

## Selecting functioning:



Accessory	Electrical connections	LED indication of functions
<p><b>Safety edge in closing:</b></p>	<p><i>In series if safety edges are mechanical, NC</i></p> <p><i>In parallel if safety edges are resistive 8,2 k<math>\Omega</math></i></p> <p><b>Safety edge selection:</b></p> <p>NC safety edge (JA1 jumper)</p> <p>8,2 k<math>\Omega</math> resistive safety edge</p>	<p><b>Normally alight:</b> whenever the safety edge is engaged, the LED goes off</p>
<p><b>Safety edge in opening:</b></p>	<p><i>In series if safety edges are mechanical, NC</i></p> <p><i>In parallel if safety edges are resistive 8,2 k<math>\Omega</math></i></p> <p><b>Safety edge selection:</b></p> <p>NC safety edge (JA2 jumper)</p> <p>8,2 k<math>\Omega</math> resistive safety edge</p>	<p><b>Normally alight:</b> whenever the safety edge is engaged, the LED goes off</p>





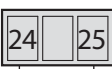





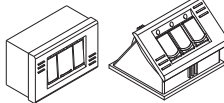
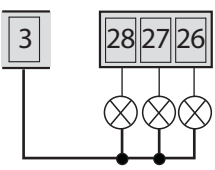

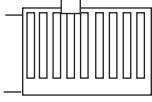
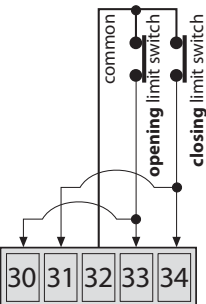
## ELECTRICAL CONNECTIONS ON SLIDING GATE MODE - dip-switch - B n° 1 = ON

Accessory	Electrical connections	Dip-switch setting and LED indication of functions
<b>24 Vac output:</b> 	 24 Vac OUTPUT - max load: No. 3 pairs of photocells No. 1 radio receiver No. 1 LED Chis 37 / Chis-E 37 key-switch <i>Instructions are attached to the related control accessories</i>	
<b>Gate electric lock:</b> 	 Power supply output 12 Vac/dc or 24 Vac/dc for an <b>electric lock</b> , 15 VA max  "STRIP" JUMPER LOCK SETUP  Power supply for a mechanical release lock LOCK SETUP  Power supply for a magnetic lock to hold the gate/s on gate stop/s  AC  = alternated current output DC  = direct current output	 <b>ELECTRIC LOCK TIME</b> 0,5 s - 20 s   12 V electric lock power supply   24 V electric lock power supply
<b>Output for single-phase motors</b> <b>230 V - 350 W max - 0,5 HP:</b>	<b>In case of one motor only:</b> 1) Connect power supply to the terminals motor M1 2) No gate delay in opening by <b>dip-A n° 8 = ON</b> 3) Set the trimmer gate delay in closing to zero  <b>In case of 2 motors:</b> 1) Connect power supply to the terminals motors M1 and M2 2) No gate delay in opening by <b>dip-A n° 8 = ON</b> 3) Set the trimmer gate delay in closing to zero  	 <b>MOTOR RUN TIME</b> OPEN - CLOSE 0 s - 120 s   <b>DWELL TIME</b> 1 s - 220 s
<b>Flasher 230 Vac:</b> 	  <b>230 Vac OUTPUT</b> flasher max 25 W	<b>DIP-SWITCH - A N° 4 and N° 10:</b>  <b>ON:</b> pre-flashing before movement  <b>OFF:</b> no pre-flashing   <b>ON:</b> flasher out of service in dwell time automatic mode ( <b>dip 3 = ON</b> )  <b>OFF:</b> flasher in service in dwell time automatic mode ( <b>dip 3 = ON</b> )
<b>PCB power supply 230 V:</b>	 <b>Control board power supply</b> 230 V - 50/60 Hz ±10% NEUTRAL LIVE	

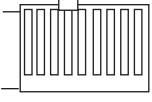
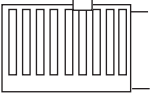
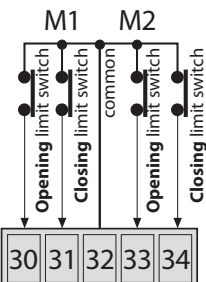

## ELECTRICAL CONNECTIONS ON SLIDING GATE MODE - dip-switch - B n° 1 = ON

Accessory	Electrical connections	LED indication of functions
<b>Power connections to Pulin 3 LEDs:</b> 	 <p>Terminals for the connections of the LEDs of the push buttons <b>Pulin 3</b></p>	
<b>24 Vdc - 5 W output:</b>	 <p>OUTPUT 24 Vdc - 5 W max</p>	
<b>Single sliding gate limit switches:</b>  <p>In applications where <u>only one motor</u> is fitted, connect the inputs of the M1 and M2 limit switches be put in "parallel" (bridge 30 with 33 and 31 with 34, and then connect them to the limit switches open - close).</p> <p><b>IMPORTANT:</b> if <b>no limit switches</b>, are involved, link out terminals 30 - 31 - 32 - 33 - 34. Limit switches (L-sw.) must have normally closed contacts</p>		<ul style="list-style-type: none"> <li> <b>L30 ON</b> = OFF on engaging L.sw. Opening</li> <li> <b>L31 ON</b> = OFF on engaging L.sw. Closing</li> <li> <b>L33 ON</b> = OFF on engaging L.sw. Opening</li> <li> <b>L34 ON</b> = OFF on engaging L.sw. Closing</li> </ul>
<b>Double sliding gate limit switches:</b>   <p>In applications where two motors are fitted, connect the normally closed limit switches to the respective input terminals.</p> <p><b>IMPORTANT:</b> if <b>no limit switches</b> are involved, link out terminals 30 - 31 - 32 - 33 - 34. Limit switches (L-sw.) must have normally closed contacts</p>		<ul style="list-style-type: none"> <li> <b>L30 ON</b> = OFF on engaging L.sw. Opening M1</li> <li> <b>L31 ON</b> = OFF on engaging L.sw. Closing M1</li> <li> <b>L33 ON</b> = OFF on engaging L.sw. Opening M2</li> <li> <b>L34 ON</b> = OFF on engaging L.sw. Closing M2</li> </ul>

**Traffic lights plug-in card (optional - Item No. 7282L):**

The power supply of this card is independent from that of the control board: 230 V - 50 Hz with an output of 100 W at 230 V each lamp.

**Logic of operation:**

- **GREEN** light = driveway **OPEN**
  - **RED** light = driveway **CLOSED**
  - **YELLOW** light = it switches on before light changes from green to red
- Note:** in **pedestrians** mode the traffic light is always **RED**.

**Dip-switch - A**

- 4 = ON** Pre-flashing enabled: traffic lights red - yellow - green
- 4 = OFF** Pre-flashing disabled: traffic lights red - green

**6 = ON** Limit switches installed

**6 = OFF** Limit switches linked out (functioning by time setting)

**Dip-Switch - B**

- 3 = ON** Pre-flashing time prolonged by about 2 seconds (yellow light up to 3 seconds)
- 3 = OFF** Standard time as factory-preset

**Functioning with 2 lamps (red and green):**

- Dip-switch - A** **4 = OFF**
- Dip-switch - A** **6 =** adjust setting depending on whether the limit switches are used or not in the installation

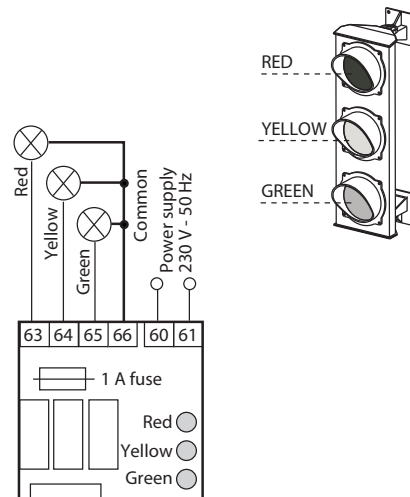

**Dip-Switch - B** **3 = OFF**

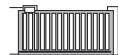

**(Optional):**  
traffic lights plug-in card  
for 230 V lamps)  
**item 7282L**

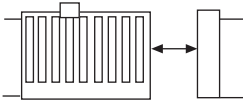

## FUNCTIONS FOR SLIDING GATE OPENING - dip-switch - B n° 1 = ON

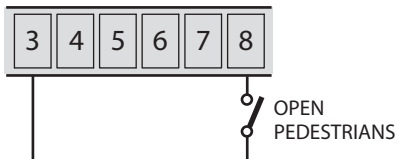
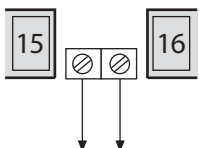
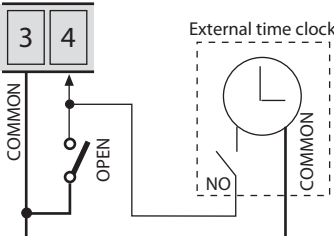
Description	Dip-switch setting and LED indication of functions
<p><b>AUTOMATIC / SEMI-AUTOMATIC:</b></p> <p><b>Automatic cycle:</b> by one pulse from the open command the gate opens and stops in dwell mode for the time as pre-set on the <b>dwell trimmer</b>. When this time expires the gate closes automatically.</p> <p><b>Semi-automatic cycle:</b> by one pulse from the open command the gate opens and stops in fully open position. To close the gate, a close pulse is needed.</p>	<p><b>DIP-SWITCH - A N° 3:</b></p> <ul style="list-style-type: none"> <li><input checked="" type="checkbox"/> <b>ON:</b> automatic closing</li> <li><input type="checkbox"/> <b>3 OFF:</b> semi-automatic, closing by pulse</li> </ul> <p> <b>Dwell trimmer:</b> adjust dwell time on automatic mode from 1 s up to 220 s</p>
<p><b>PEDESTRIAN OPENING:</b></p> <p>With the gate in fully closed position, a pulse to terminals 3-8 operates the gate for pedestrians.</p> <p>(On pedestrian mode, it is advisable to set dip-A n° 3 = ON for automatic re-closing).</p> <p>The function <b>pedestrian opening</b> is not in service during the first operation cycle, after a power failure.</p>  <p><b>RIT. C</b></p> <p> <b>OPENING FOR PEDESTRIANS</b> 1 s - 45 s</p>	<p><input type="checkbox"/> <b>L8 OFF</b> = no pedestrian contact given, it goes on by pulsing for pedestrians</p> 
<p><b>RE-CLOSING BY PASSING ACROSS THE PHOTOCELLS:</b> <b>in opening and dwell cycles (DIP-A N° 3 = ON)</b></p> <p>Gate is automatically closed after 3 s from passing between the photocells.</p> <p>In case a second pair of photocells are installed, (dip-9 = ON), both pairs are to be passed across.</p>	<p><b>DIP-SWITCH - A N° 9 and N° 11:</b></p> <ul style="list-style-type: none"> <li><input checked="" type="checkbox"/> <b>ON:</b> 2<sup>nd</sup> pair photocells enabled</li> <li><input type="checkbox"/> <b>9 OFF:</b> 2<sup>nd</sup> pair photocells not installed</li> </ul> <ul style="list-style-type: none"> <li><input checked="" type="checkbox"/> <b>ON:</b> automatic closing on passing across the photocells after 3 seconds</li> <li><input type="checkbox"/> <b>11 OFF:</b> no automatic closing on passing across the photocells after 3 seconds</li> </ul>
<p><b>DSA: PHOTOCCELL AUTOMATIC CONTROL</b></p> <p>For the <b>DSA control (Device for Safety Auto-test)</b> it is necessary to connect <b>only the photocell transmitters (TX)</b> to this output and select <b>dip-B n° 4 = ON:</b> if this function is enabled, Elpro 27 checks that all the connected photocell devices are cleared from obstacles and properly working before starting any door/gate movements, otherwise the door/gate is not started.</p>  <p><b>24 Vac output</b> for photocell transmitter TX enabled for <b>DSA control</b></p>	<p><b>DIP-SWITCH - B N° 4:</b></p> <ul style="list-style-type: none"> <li><input checked="" type="checkbox"/> <b>ON:</b> DSA safety control enabled</li> <li><input type="checkbox"/> <b>4 OFF:</b> DSA safety control disabled</li> </ul>
<p><b>DEADMAN (HOLD-ON-SWITCHED) FUNCTION:</b></p> <p>The open/close operations are achieved by <i>holding on a command switched</i> (the relays are not self-holding) and consequently the user must be actively present during gate movements until the push-button or the key-switch is released.</p>	<p><b>DIP-SWITCH - B N° 2:</b></p> <ul style="list-style-type: none"> <li><input checked="" type="checkbox"/> <b>ON:</b> deadman control enabled</li> <li><input type="checkbox"/> <b>2 OFF:</b> deadman control disabled</li> </ul>
<p><b>PARTY FUNCTION</b> <b>OPEN-AND-HOLD BY EXTERNAL CLOCK:</b></p> <p><b>Connection:</b> connect the clock NO contact to OPEN terminals n° 4 and COMMON n° 3, and activate automatic closing by dip-switch n° 3 = ON.</p> <p><b>How it works:</b> program the opening time on the clock. At the preset time, the gate will open and remain open (the flashing light will turn off) and <b>will not accept any other command</b> (not even radio commands) until the time set on the clock expires.</p> <p>When this time expires the <b>gate closes automatically after the pause time</b>. While the gate is held open by the time set on the <i>clock</i>, the indication light keeps giving out two consecutive flashes followed by a long pause.</p> 	<p><b>DIP-SWITCH - A N° 3:</b></p> <ul style="list-style-type: none"> <li><input checked="" type="checkbox"/> <b>ON:</b> automatic closing</li> <li><input type="checkbox"/> <b>3 OFF:</b> (not explicitly defined in this block)</li> </ul> <p><b>IMPORTANT:</b> use always and only with dip-A N° 3 = ON</p>





FOR SWINGING GATE AUTOMATIC SYSTEMS:

set dip-switch - B n° 1 = OFF

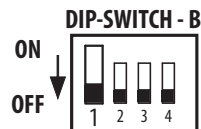

**Dip-switch A**

- 1 = ON Photocells stop gate in opening
- 2 = ON Radio, no reversing in opening
- 3 = ON Automatic closing
- 4 = ON Pre-flashing in service
- 5 = ON Radio step-by-step
- 6 = ON Traffic lights mode limit switches connected

- 7 = ON Stroke reversing pulse in opening cycle
- 8 = ON No gate delay in opening, motors start together
- 9 = ON 2<sup>nd</sup> pair photocells in service
- 10 = ON Flasher off in dwell time
- 11 = ON Gate re-closing in opening and dwell on engaging the photocells
- 12 = ON Memory of motor run time settings enabled, with installations where very frequent operations are required

**DIP-SWITCH - A**



**Dip-switch B**

- 1 = OFF SWINGING GATE mode
- 2 = ON Hold-on-switched (deadman) control
- 3 = ON Traffic lights "yellow" for 3 seconds
- 4 = ON DSA control by photocell transmitters if connected to the dedicated terminals

**DIP-SWITCH - B**



ELECTRICAL CONNECTIONS ON SWINGING GATE MODE - dip-switch - B n° 1 = OFF

Accessory	Electrical connections	Dip-switch setting and LED indication of functions
<p><b>2<sup>nd</sup> pair photocells (fitted inside perimeter):</b></p>	<p>This pair of photocells stops gate in opening; once cleared from obstacle, gate goes on opening, gate travel is reversed in closing.</p> <p><b>Dip-A n° 9 = ON and the NC contact connected:</b> the gates stay stopped as long as the photocells are obstructed.</p> <ul style="list-style-type: none"> <li>- In opening cycle: obstacle removed, gates go on opening</li> <li>- In closing cycle: obstacle removed, gate travel reversed</li> </ul> <p><b>NOTE: if no 2<sup>nd</sup> pair photocells are used, it is not necessary to bridge the contact input, only dip-A n° 9 = OFF</b></p>	<p><b>DIP-SWITCH - A N° 9:</b></p> <ul style="list-style-type: none"> <li><input checked="" type="checkbox"/> ON: Photocells 2<sup>nd</sup> pair in service</li> <li><input type="checkbox"/> OFF: Photocells 2<sup>nd</sup> pair not installed</li> </ul> <p> <b>L0 ON</b> = no obstacle detected, it goes off in case of obstacle</p>
<p><b>1<sup>st</sup> pair photocells (fitted outside perimeter):</b></p>	<p><b>24 Vac output max load:</b> n° 1 radio receiver n° 3 pairs photocells</p> <p>All of the NC contacts of the safety accessories such as the photocells (receivers) are to be series connected to terminals 1 and 2</p>	<p><b>DIP-SWITCH - A N° 1:</b></p> <ul style="list-style-type: none"> <li><input checked="" type="checkbox"/> ON: stop gate/s in opening and reverse travel in closing when cleared</li> <li><input type="checkbox"/> OFF: no stop in opening and reverse travel in closing when obstructed</li> </ul> <p> <b>L1 ON</b> = no obstacle detected, it goes off in case of obstacle</p>
<p><b>Key-switch:</b></p>	<p>NO and NC contacts to be connected to the respective terminals in the key- or button-switches. All of the possible setting combinations are described in the instructions sheets included with the respective control accessories</p>	<ul style="list-style-type: none"> <li><input type="checkbox"/> <b>L4 OFF</b> = no OPENING contact, it goes on whenever an opening pulse is given</li> <li><input type="checkbox"/> <b>L5 OFF</b> = no CLOSING contact, it goes on whenever a closing pulse is given</li> <li> <b>L6 ON</b> = STOP contact closed, it goes off whenever a stop pulse is given</li> </ul>
<p><b>Radio contact (step by step mode):</b></p>	<p>Any NO connection to these two terminals will perform the following:</p> <ul style="list-style-type: none"> <li>- Opening only: <b>dip 2 = ON and dip 5 = OFF</b></li> <li>- Gate travel reversing by any pulse <b>dip 2 = OFF and dip 5 = OFF</b></li> <li>- Step by step: open-stop-close-stop <b>dip 2 = OFF and dip 5 = ON</b></li> <li>- No new pulse is accepted in opening. In Dwell phase and in closing any new pulse stops and reverses gate travel: <b>dip 2 = ON and dip 5 = ON</b></li> </ul>	<p><b>DIP-SWITCH - A N° 2 and N° 5:</b></p> <ul style="list-style-type: none"> <li><input checked="" type="checkbox"/> ON: it does not stop and reverse gate travel in opening</li> <li><input type="checkbox"/> OFF: always stops &amp; reverses in opening</li> </ul> <ul style="list-style-type: none"> <li><input checked="" type="checkbox"/> ON: step by step with intermediate stop</li> <li><input type="checkbox"/> OFF: gate travel reversed by any radio pulse</li> </ul> <p><input type="checkbox"/> <b>L7 OFF</b> = no RADIO contact, it goes on by any radio pulse</p>
<p><b>Indication lamp output 24 V max 3 W:</b></p>	<p>Output for a 24 V max 3 W indication lamp showing the status of the system:</p> <ul style="list-style-type: none"> <li>Lamp ON = gate open</li> <li>Lamp OFF = gate closed</li> <li><b>0,5 s (fast) flashing</b> = gate closing</li> <li><b>1 s (normal) flashing</b> = gate opening</li> </ul>	

Dip-B N° 1 = OFF

FOR SWINGING GATE SYSTEMS



## SAFETY EDGES

The two inputs, that are fitted to control the safety edges, are separated for the opening and closing phases. Also, it is possible to select the type of contact connected to them, either NC mechanical or 8,2 kΩ resistive, by means of the two jumpers JA1 or JA2.

Thanks to a dedicated microcontroller circuit separately fitted on to the board, the actual integrity and correct functioning of the safety system is constantly controlled. Any possible fault or loss of efficiency is signalled by the L10 and L35 LEDs keeping flashing.

## Selecting functioning:

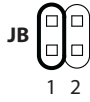

Gate travel is reversed on opening and closing for a short spell.

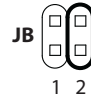

Once the safety edge has been engaged and the obstacle removed, the gate closes automatically (if automatic close mode has been selected).

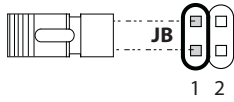

(JB1 jumper)

Gate travel is reversed in opening and closing for twice as much the spell.

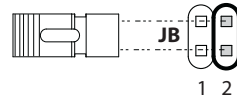







(JB2 jumper)

Once the safety edge has been engaged and the obstacle removed, the gate stays stopped until a new pulse is given (even if automatic close mode has been selected).

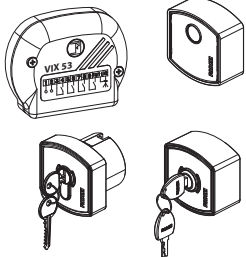
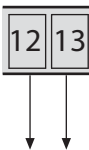
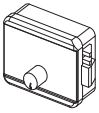
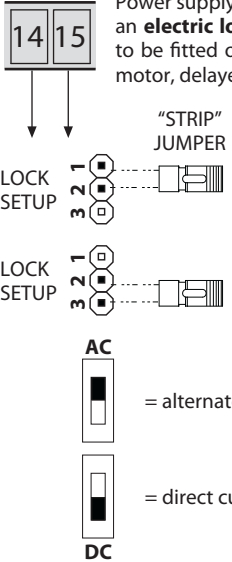
Accessory	Electrical connections	LED indication of functions
<p><b>Safety edge in closing:</b></p>	<p><i>In series if safety edges are mechanical, NC</i></p> <p><i>In parallel if safety edges are resistive 8,2 kΩ</i></p> <p><b>Safety edge selection:</b></p> <p>NC safety edge (JA1 jumper)</p> <p>8,2 kΩ resistive safety edge</p>	<p><b>Normally alight:</b> whenever the safety edge is engaged, the LED goes off</p>
<p><b>Safety edge in opening:</b></p>	<p><i>In series if safety edges are mechanical, NC</i></p> <p><i>In parallel if safety edges are resistive 8,2 kΩ</i></p> <p><b>Safety edge selection:</b></p> <p>NC safety edge (JA2 jumper)</p> <p>8,2 kΩ resistive safety edge</p>	<p><b>Normally alight:</b> whenever the safety edge is engaged, the LED goes off</p>

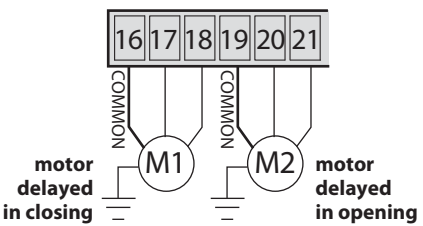



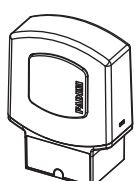
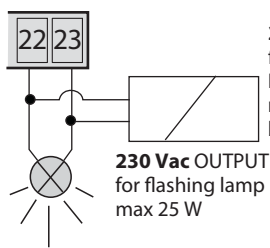
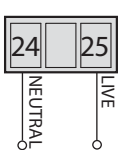

## ELECTRICAL CONNECTIONS ON SWINGING GATE MODE - dip-switch - B n° 1 = OFF

Accessory	Electrical connections	Dip-switch setting and LED indication of functions
<b>24 Vac output:</b> 	 <p>24 Vac OUTPUT - max load: No. 3 pairs of photocells No. 1 radio receiver No. 1 LED Chis 37 / Chis-E 37 key-switch <i>Instructions are attached to the related control accessories</i></p>	
<b>Gate electric lock:</b> 	 <p>Power supply output 12 Vac/dc or 24 Vac/dc for an <b>electric lock</b>, 15 VA max. The electric lock is to be fitted onto the gate operated by the M1 motor, delayed in closing cycle.</p> <p>"STRIP" JUMPER</p> <p>LOCK SETUP 1 2 3 1 2 3 Power supply for a mechanical release lock</p> <p>LOCK SETUP 1 2 3 1 2 3 Power supply for a magnetic lock to hold the gate/s on gate stop/s</p> <p>AC = alternated current output DC = direct current output</p>	 <p><b>ELECTRIC LOCK TIME</b> 0,5 s - 20 s</p> <p>12 V 3 2 1 12 V electric lock power supply</p> <p>24 V 3 2 1 24 V electric lock power supply</p>
<b>Output for single-phase motors</b> <b>230 V - 350 W max - 0,5 HP:</b>	<p><b>In case of one motor only:</b> 1) Connect power supply to the terminals motor M1 2) No gate delay in opening by <b>dip-A n° 8 = ON</b> 3) Set the trimmer gate delay in closing to zero</p> <p><b>In case of 2 motors:</b> Gate delay in opening, with a fixed time of 2 s: if required, it must be enabled by <b>dip-A n° 8 = OFF</b></p>  <p>motor delayed in closing M1 M2 motor delayed in opening</p>	 <p><b>MOTOR RUN TIME OPEN-CLOSE</b> 0 s - 60 s</p>  <p><b>DWELL TIME</b> 1 s - 220 s</p>  <p><b>GATE DELAY IN CLOSING</b> 0 s - 10 s</p> <p><b>DIP-SWITCH - A N° 8:</b></p> <p><input type="checkbox"/> ON: no gate delay in opening <input checked="" type="checkbox"/> OFF: 2 s gate delay in opening enabled</p>
<b>Electric latch and flashing lamp 230 Vac:</b> 	 <p>230 Vac OUTPUT for electric latch. <b>Important: power supply must be off during dwell time by dip-A n° 10 = ON</b></p> <p>230 Vac OUTPUT for flashing lamp max 25 W</p>	<p><b>DIP-SWITCH - A N° 4 and N° 10:</b></p> <p><input type="checkbox"/> ON: pre-flashing before movement <input checked="" type="checkbox"/> OFF: no pre-flashing</p> <p><input type="checkbox"/> ON: out of service in dwell phase automatic mode (by <b>dip 3 = ON</b>) <input checked="" type="checkbox"/> OFF: powered, ie. in service in dwell phase automatic mode (by <b>dip 3 = ON</b>)</p>
<b>Board power supply 230 V:</b>	 <p>Electronic control board power supply 230 V - 50/60 Hz ± 10%</p>	

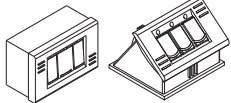
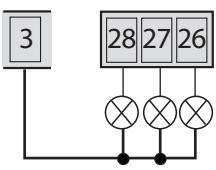

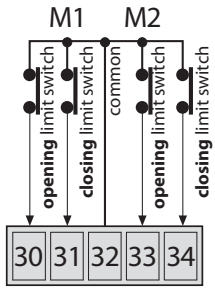
## ELECTRICAL CONNECTIONS ON SWINGING GATE MODE - dip-switch - B n° 1 = OFF

Accessory	Electrical connections	LED indication of functions
<b>Power connections to Pulin 3 LEDs:</b> 	 <p>Terminals for the connections of the LEDs of the push buttons <b>Pulin 3</b></p>	
<b>24 Vdc - 5 W output:</b>	 <p>OUTPUT 24 Vdc - 5 W max</p>	
<b>Limit switches:</b>	<p><b>IMPORTANT:</b> if <b>no limit switches</b> are involved, link out terminals 30 - 31 - 32 - 33 - 34. Limit switches (L-sw.) must have normally closed contacts.</p> 	 <p><b>L30 ON</b> = OFF on engaging L.sw. Opening M1</p> <p><b>L31 ON</b> = OFF on engaging L.sw. Closing M1</p> <p><b>L33 ON</b> = OFF on engaging L.sw. Opening M2</p> <p><b>L34 ON</b> = OFF on engaging L.sw. Closing M2</p>

**Traffic lights plug-in card (optional - Item No. 7282L):**

The power supply of this card is independent from that of the control board:  
230 V - 50 Hz with an output of 100 W at 230 V each lamp.

**Logic of operation:**

- **GREEN** light = driveway **OPEN**
  - **RED** light = driveway **CLOSED**
  - **YELLOW** light = it switches on before light changes from green to red
- Note:** in **pedestrians** mode the traffic light is always **RED**.

**Dip-switch - A**

- 4 = ON** Pre-flashing enabled: traffic lights red - yellow - green
- 4 = OFF** Pre-flashing disabled: traffic lights red - green

**6 = ON** Limit switches installed

**6 = OFF** Limit switches linked out (functioning by time setting)

**Dip-Switch - B**

**3 = ON** Pre-flashing time prolonged by about 2 seconds  
(yellow light up to 3 seconds)

**3 = OFF** Standard time as factory-preset

**Functioning with 2 lamps (red and green):**

**Dip-switch - A**      **4 = OFF**

**Dip-switch - A**      **6 =** adjust setting depending on whether the limit switches are used or not in the installation

**Dip-Switch - B**      **3 = OFF**

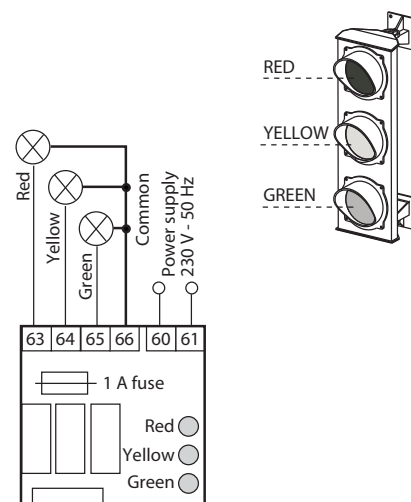

**(Optional):**  
traffic lights plug-in card  
for 230 V lamps)  
item **7282L**



## FUNCTIONS FOR SWINGING GATE OPENING - dip-switch - B n° 1 = OFF

## Description

## Dip-switch setting and LED indication of functions

**AUTOMATIC / SEMI-AUTOMATIC:**

**Automatic cycle:** by one pulse from the open command the gate opens and stops in dwell mode for the time as pre-set on the **dwell trimmer**. When this time expires the gate closes automatically.

**Semi-automatic cycle:** by one pulse from the open command the gate opens and stops in fully open position. To close the gate, a close pulse is needed.

**DIP-SWITCH - A N° 3:**

- ON:** automatic closing
- 3 OFF:** semi-automatic, closing by pulse



**Dwell trimmer:** adjust dwell time on automatic mode from 1 s up to 220 s

**PEDESTRIAN OPENING ONLY FOR MOTOR M1:**

With the gate in fully closed position, a pulse to terminals 3-8 operates the gate for pedestrians.

(On pedestrian mode, it is advisable to set dip-A n° 3 = ON for automatic re-closing).

The function **pedestrian opening** is not in service during the first operation cycle, after a power failure.

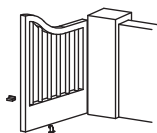

- L8 OFF =** no pedestrian contact given, it goes on by pulsing for pedestrians

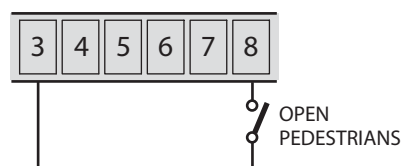
**RE-CLOSING BY PASSING ACROSS THE PHOTOCELLS:**

**in opening and dwell cycles (DIP-A N° 3 = ON)**

Gate is automatically closed after 3 s from passing between the photocells.

In case a second pair of photocells are installed, (dip-9 = ON), both pairs are to be bypassed across.

**DIP-SWITCH - A N° 9 and N° 11:**

- ON:** 2<sup>nd</sup> pair photocells enabled
- 9 OFF:** 2<sup>nd</sup> pair photocells not installed

- ON:** automatic closing on passing across the photocells after 3 seconds
- 11 OFF:** no automatic closing on passing across the photocells after 3 seconds

**DSA: PHOTOCCELL AUTOMATIC CONTROL**

For the **DSA control (Device for Safety Auto-test)** it is necessary to connect **only the photocell transmitters (TX)** to this output and select **dip-B n° 4 = ON**: if this function is enabled, Elpro 27 checks that all the connected photocell devices are cleared from obstacles and properly working before starting any door/gate movements, otherwise the door/gate is not started.

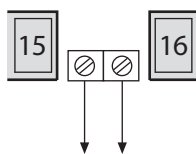

**24 Vac output**  
for photocell transmitter TX  
enabled for **DSA control**

**DIP-SWITCH - B N° 4:**

- ON:** DSA safety control enabled
- 4 OFF:** DSA safety control disabled

**DEADMAN (HOLD-ON-SWITCHED) FUNCTION:**

The open/close operations are achieved by **holding on a command switched** (the relays are not self-holding) and consequently the user must be actively present during gate movements until the push-button or the key-switch is released.

**DIP-SWITCH - B N° 2:**

- ON:** deadman control enabled
- 2 OFF:** deadman control disabled

**STROKE REVERSING PULSE IN OPENING CYCLE:**

This function helps the gate electric lock to release with the gate/s in fully closed position, even in **pedestrians** mode: the gates in closed position are pushed to close direction for **2 seconds** before the opening cycle begins.

**DIP-SWITCH - A N° 7:**

- ON:** stroke reversing pulse in opening enabled for 2 s
- 7 OFF:** no stroke reversing pulse

**APPLICATIONS IN BLOCKS OF FLATS:**

This is a function for heavy duty applications with frequent inversions of direction: this function, when enabled, takes into account the remaining motor run time when there is an inversion of direction or passage between the photocells.

**DIP-SWITCH - A N° 12:**

- ON:** memory of motor run time settings enabled
- 12 OFF:** no memory enabled

**PARTY FUNCTION****OPEN-AND-HOLD BY EXTERNAL CLOCK:**

**Connection:** connect the clock NO contact to OPEN terminals n° 4 and COMMON n° 3, and activate automatic closing by dip-switch n° 3 = ON.

**How it works:** program the opening time on the clock. At the preset time, the gate will open and remain open (the flashing light will turn off) and **will not accept any other command** (not even radio commands) until the time set on the clock expires.

When this time expires the **gate closes automatically after the pause time**. While the gate is held open by the time set on the **clock**, the indication light keeps giving out two consecutive flashes followed by a long pause.

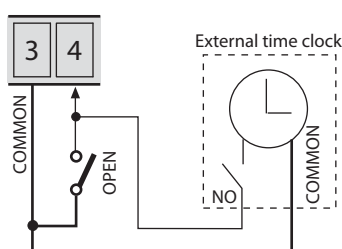
**DIP-SWITCH - A N° 3:**

- ON:** automatic closing
- 3**

**IMPORTANT:**  
use always and only with dip-A N° 3 = ON

**AVERTISSEMENTS DE SECURITE AUX USAGERS****NOUS VOUS REMERCIONS**

Nous vous remercions d'avoir acheté un produit Fadini. Veuillez lire attentivement ces instructions avant d'utiliser l'appareil. Ces instructions sont des informations utiles vous permettant de mieux exploiter cet appareil, et vous assurer une installation, une utilisation et un entretien sécurisés et adéquats. Veuillez bien garder ce manuel et toujours vous y référer pour une utilisation sécurisée et adéquate de l'appareil.

**INTRODUCTION**

Cet automatisme a été conçu pour une utilisation qui respecte ce qu'il y a indiqué dans ce livret, avec les accessoires de sécurité et de signalisation minimaux demandés et avec les dispositifs Fadini. □ Toute autre application pas expressément indiquée dans ce livret pourrait provoquer des dysfonctionnements ou des dommages à choses et personnes. □ Meccanica Fadini n'est pas responsable d'éventuels dommages provoqués par une utilisation impropre et non spécifiquement indiquée dans ce livret. En outre, elle n'est pas responsable des dysfonctionnements causés de l'usage de matériels ou accessoires non recommandés par le fabricant. □ L'entreprise de construction se réserve le droit d'apporter des modifications aux propres produits sans préavis. □ Tout ce qui n'est pas prévue dans cette notice d'installation n'est pas permis.

**INSTRUCTIONS A SUIVRE AVANT L'INSTALLATION**

Contrôler avant toute intervention que l'entrée soit adapté à l'automatisation, ainsi que ces conditions et structure. □ Assurez-vous qu'y ne soit pas des risques d'impact, écrasement, cisaillement, convoyage, entraînement et enlèvement, tels qu'on pourrait affecter la sécurité des personnes. □ Installer l'automatisme loin de tout sources de chaleur et éviter le contact avec substances inflammables. □ Garder tout dispositifs de contrôle automatisme (émetteurs, lecteurs de proximité, sélecteurs etc) hors de la portée des enfants. □ Transiter à travers la zone du mouvement du portail seulement lorsque l'automatisme est fermé. □ Afin de garantir un niveau de sécurité adéquat de l'installation il est nécessaire d'utiliser photocellules, listeaux sensibles, spires magnétiques, détecteurs de masse métalliques, en assurant la sécurité de tout l'aire de mouvement du portail. □ Identifier les points dangereux de l'installation en l'en indiquant avec bandes jaune-noir ou autres signaux appropriés. □ Couper l'alimentation avant toute intervention d'entretien ou nettoyage de l'installation. □ Dans le cas on doit enlever l'opérateur du portail, ne pas couper les fils électrique; mais les débrancher en desserrant les vis du bornier.

**L'INSTALLATION**

Toute l'installation doit être accomplie par personnel technique qualifié et autorisé, conformément à la directive Machines 2006/42/CE et, notamment, aux normes EN 12445 et EN 12453. □ Vérifier la présence en amont de l'installation d'un interrupteur différentiel magnétothermique de 0,03 A de courant 230 V - 50 Hz. □ Utiliser des objets approprié pour effectuer les tests de fonctionnement des photocellules, détecteurs des masses métalliques, listeaux sensibles, etc. □ Effectuer une analyse des risques, en utilisant instruments de détection de l'impact et écrasement du bord principale d'ouverture et fermeture, conformément aux normes EN 12445. □ Définir les solutions appropriées pour éliminer ou réduire tels risques. □ Dans le cas où le portail à automatiser aurait doué d'une entrée piétonne, il serait bon d'accomplir l'installation de façon que le moteur ne fonctionne pas lorsque l'entrée piéton est utilisé. □ Fournir des indications concernant la position de l'installation en appliquant sur le portail des plaquettes de signalisation marquée CE. □ L'installateur doit informer l'utilisateur sur le fonctionnement correct du système, en lui remettant le dossier technique signé, incluant: le schéma et les éléments composants l'installation,

l'analyse des risques, la vérification des accessoires de sécurité, la vérification de la force d'impact et la déclaration des risques résiduels.

**INDICATIONS POUR L'UTILISATEUR FINAL**

L'utilisateur doit consulter et recevoir information relative au fonctionnement de l'installation et il devient lui-même responsable du bon usage du système. □ Il faut qu'il conclue un contrat d'entretien ordinaire et extraordinaire (sur appel) avec l'installateur/réparateur. □ Toute l'intervention d'entretien doivent être accompli par des techniciens qualifiés. □ Conserver toujours la notice d'installation.

**AVERTISSEMENTS POUR LE FONCTIONNEMENT CORRECT DE L'INSTALLATION**

Pour que l'installation fonctionne correctement de façon durable et conformément aux normes de sécurité en vigueur, vous devez faire effectuer un entretien correct et le monitoring de toute l'installation au niveau de l'automatisme, des appareils électroniques installés et des câblages qui y sont branchés. □ Toute l'installation doit être effectuée par un technicien qualifié, qui doit remplir le Manuel d'Entretien indiqué dans le Livret des Normes (à demander ou télécharger sur le site [www.fadini.net/supporto/downloads](http://www.fadini.net/supporto/downloads)). □ L'automatisme: contrôle d'entretien tous les 6 mois au moins, tandis que le contrôle d'entretien des appareils électroniques et systèmes de sécurité doit être accompli une fois par mois au moins. □ Meccanica Fadini S.r.l. n'est pas responsable de l'éventuel non-respect des règles de bonne technique d'installation et/ou de l'entretien incorrect du système.

**RAMASSAGE DES MATERIAUX**

Les éléments d'emballage, tels que le carton, nylon, polystyrène, etc. peuvent être recyclés avec le collecte séparé (en vérifiant la réglementation en vigueur en la matière dans le pays où le dispositif est monté). Les composants électriques et électroniques, les batteries peuvent contenir des substances polluantes: enlever et confier tels composants aux sociétés chargées du traitement et de l'élimination des déchets, dans le respect de la directive 2012/19/UE. Ne pas jeter déchets nuisibles à l'environnement.

**DECLARATION UE DE CONFORMITE**

Fabricant: Meccanica Fadini S.r.l.  
Adresse: Via Mantova, 177/A - 37053 Cerea - VR - Italy

déclare sous sa propre responsabilité que le produit:

Programmateur électronique modèle **ELPRO 27**

il est conforme à la législation d'harmonisation de l'Union:

- Directive Compatibilité Electromagnétique 2014/30/UE  
- Directive Basse Tension 2014/35/UE

Cerea, 19/04/2017

Meccanica Fadini S.r.l.  
Directeur Responsable





**ATTENTION: avant de faire les raccordements électriques, sélectionnez la typologie d'automatisation en utilisant le dip-switch B n° 1 et lisez les instructions dédiées aux différentes typologies d'ouvre-portails:**  
**COULISSANTS de page 27 à la page 32 - BATTANTS de page 33 à la page 37.**

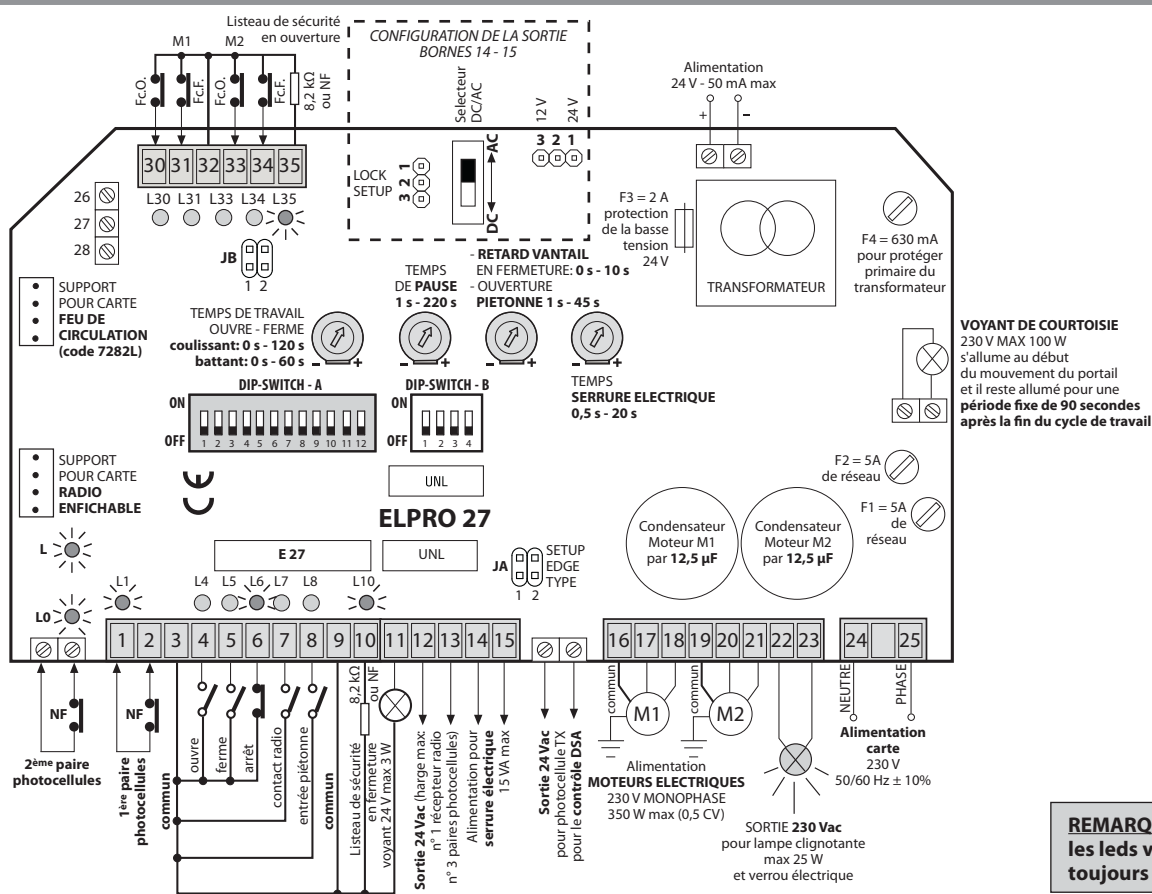

**Description générale:** le programmeur électronique **ELPRO 27** a été réalisée comme une solution possible pour la gestion d'un coulisseau automatisé avec ou sans fin de course avec 1 ou 2 vantaux, systèmes à battant avec 1 ou 2 vantaux, avec valve de réglage de la force; est alimentés à 230 V - 50/60 Hz monophasé. L'entreprise de construction ne s'assume pas des responsabilités en ce qui concerne l'usage incorrect du programmeur; et elle se réserve le droit d'apporter des modifications au programmeur en n'importe quel moment.

#### NOTICES IMPORTANTES POUR LA CORRECTE INSTALLATION ET LE CORRECT FONCTIONNEMENT:

- Le programmeur doit être installé dans un lieu sec et abrité.
  - Assurez-vous que l'alimentation du programmeur électronique soit 230 V  $\pm 10\%$ .
  - Assurez-vous que l'alimentation du moteur électrique soit 230 V  $\pm 10\%$ .
  - Augmentez-vous la section des fils pour des distances supérieures aux 50 mètres.
  - Appliquez-vous à l'alimentation du programmeur un interrupteur magnéto-thermique différentiel du type 0,03 A à haute sensibilité.
  - Pour l'alimentation, le moteur électrique, la lampe clignotante utilisez des fils avec section de 1,5 mm<sup>2</sup> jusqu'à 50 m de distance.
  - Pour les fins de course, les photocellules, les boîtes à boutons poussoirs et les accessoires utilisez des câbles avec fils de 1 mm<sup>2</sup>.
  - Si on n'utilise pas les photocellules, faites un pontage entre les bornes 1 et 2.
  - Si on n'utilise aucune boîte à boutons poussoirs, faites un pontage entre les bornes 3 et 6.
  - Le trimmer du temps de travail ouvre/ferme doit être toujours supérieur au temps effectif de la course du portail.
- N.B.: pour d'applications comme l'allumage des lumières, caméras, ecc. utilisez des relais statiques pour éviter de créer brouillages au microprocesseur.

#### LED DE CONTRÔLE:

- L allumée** = présence de tension de réseau 230 V et intégrité fusibles F1, F2, F3
- L0 allumée** = 2<sup>ème</sup> paire photocellules, sans obstacle
- L1 allumée** = 1<sup>ère</sup> paire photocellules, sans obstacle
- L4 éteinte** = ouvre, s'allume à l'impulsion de la commande d'ouverture
- L5 éteinte** = ferme, s'allume à l'impulsion de la commande de fermeture
- L6 allumée** = arrêt, s'éteint à l'impulsion de la commande d'arrêt
- L7 éteinte** = radio, s'allume à chaque impulsion de l'émetteur et contact radio
- L8 éteinte** = piéton, s'allume à chaque commande piéton
- L10 allumée** = listeau de sécurité fermeture
- L30 allumée** = s'éteint à Fc.O. utilisé M1
- L31 allumée** = s'éteint à Fc.F. utilisé M1
- L33 allumée** = s'éteint à Fc.O. utilisé M2
- L34 allumée** = s'éteint à Fc.F. utilisé M2
- L35 allumée** = listeau de sécurité ouverture

#### EN CAS DE MANQUE DE FONCTIONNEMENT:

- Assurez-vous que l'alimentation du programmeur électronique soit 230 V  $\pm 10\%$ .
- Assurez-vous que l'alimentation du moteur électrique soit 230 V  $\pm 10\%$
- Contrôlez-vous tous les fusibles.
- Contrôlez-vous que les photocellules soient en contact fermé.
- Contrôlez-vous qu'il n'y ait pas une chute de tension entre le programmeur Elpro et le moteur électrique.
- Contrôlez-vous tous les contacts NF du programmeur.

#### SYMBOLES:

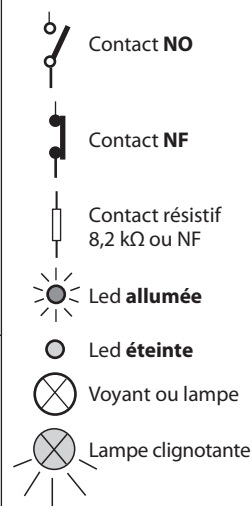

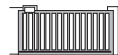

POUR OUVERE-PORTAILS COULISSANTS AVEC FINS DE COURSE:  
positionner le dip-switch - B n° 1 = ON

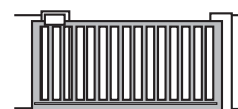
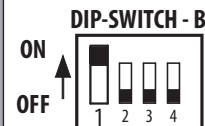
**Dip-switch A**

- 1 = ON Photocellule arrête à l'ouverture
- 2 = ON Radio n'inverse pas à l'ouverture
- 3 = ON Ferme en automatique
- 4 = ON Pré-clignotement actif
- 5 = ON Radio pas-pas
- 6 = ON Service feu de circulation avec fin de course connectée

- 7 = OFF: libre
- 8 = OFF: libre
- 9 = ON 2<sup>ème</sup> paire photocellules
- 10 = ON Lampe clignotante éteinte en pause
- 11 = ON Referme en ouverture et en pause après le passage des photocellules
- 12 = OFF: libre

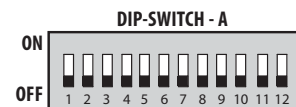
**Dip-switch B**

- 1 = ON Modalité **OUVERE-PORTAIL COULISSANT**
- 2 = ON Homme mort
- 3 = ON Feu de circulation avec "jaune" pour 3 secondes
- 4 = ON Contrôle DSA photocellules émetteurs lorsqu'il est connecté aux bornes spécifique



### RACCORDEMENTS ELECTRIQUES AUX BORNES POUR L'OUVERTURE COULISSANTE - dip-switch - B n° 1 = ON

Accessoire	Raccordements électriques	Dip-switch et LED de signalisation des différentes fonctions
<b>2<sup>ème</sup> paire photocellules (installées à l'intérieur):</b> 	<p>Cette paire de photocellules s'arrête à l'ouverture; lorsqu'il est enlevé l'obstacle, le portail continue pour ouvrir, dans la phase de fermeture inverse le sens.</p> <p>Avec <b>dip-A n° 9 = ON</b> et l'entrée <b>NF</b> raccordée: le portail reste en position arrêée pour aussi long temps que les photocellules sont engagées.</p> <ul style="list-style-type: none"> <li>- En phase d'ouverture: avec obstacle enlevé, recommence l'ouverture</li> <li>- En phase de fermeture: avec obstacle enlevé, inverse le mouvement</li> </ul> <p><b>NOTE: s'il n'y a pas l'obstacle, il n'est pas nécessaire raccorder l'entrée du contact, laissant seulement le dip-A n° 9 = OFF</b></p>	<b>DIP-SWITCH - A N° 9:</b> <ul style="list-style-type: none"> <li><input checked="" type="checkbox"/> ON: met en service la 2<sup>ème</sup> paire photocellules</li> <li><input type="checkbox"/> 9 OFF: 2<sup>ème</sup> paire photocellules pas utilisée</li> </ul> <b>L0 allumée</b> = aucun obstacle, elle s'éteint avec la présence de l'obstacle
<b>1<sup>ère</sup> paire photocellules (installées à l'externe):</b> 	<p><b>Sortie 24 Vac charge max: n° 1 récepteur radio n° 3 paires photocellules</b></p> <p>Tous les contacts NF des accessoires de sécurité comme les photocellules (récepteurs) doivent être raccordés en série aux bornes 1 et 2</p>	<b>DIP-SWITCH - A N° 1:</b> <ul style="list-style-type: none"> <li><input checked="" type="checkbox"/> ON: arrête en ouverture et inverse en fermeture avec l'obstacle enlevé</li> <li><input type="checkbox"/> 1 OFF: n'arrête pas en ouverture et inverse en fermeture avec la présence de l'obstacle</li> </ul> <b>L1 allumée</b> = aucun obstacle, elle s'éteint avec la présence de l'obstacle
<b>Sélecteur à clé:</b> 	<p>Contacts NO et NF à raccorder aux respectives bornes des sélecteurs ou des boîtes à boutons poussoirs. Toutes les possibles configurations sont jointes aux respectifs accessoires de commande</p>	<ul style="list-style-type: none"> <li><input type="radio"/> <b>L4 éteinte</b> = aucun contact OUVRE, elles'allume à chaque impulsion d'ouverture</li> <li><input type="radio"/> <b>L5 éteinte</b> = aucun contact FERME, elles'allume à chaque impulsion de fermeture</li> <li><input checked="" type="radio"/> <b>L6 allumée</b> = contact d'ARRET fermé, elle s'éteint à chaque contact d'arrêt</li> </ul>
<b>Contact radio (avec fonction pas-pas):</b> 	<p>Raccordant un contact NO entre les deux bornes on peut obtenir à chaque impulsion:</p> <ul style="list-style-type: none"> <li>- Seulement ouverture: <b>dip 2 = ON</b> et <b>dip 5 = OFF</b></li> <li>- Inversion de marche à chaque impulsion <b>dip 2 = OFF</b> et <b>dip 5 = OFF</b></li> <li>- Pas-pas: ouvre-arrêt-ferme-arrêt <b>dip 2 = OFF</b> et <b>dip 5 = ON</b></li> <li>- En phase d'ouverture il n'accepte aucune commande. En pause et en fermeture, à chaque commande, il exécute l'arrêt avec l'inversion de marche: <b>dip 2 = ON</b> et <b>dip 5 = ON</b></li> </ul>	<b>DIP-SWITCH - A N° 2 et N° 5:</b> <ul style="list-style-type: none"> <li><input checked="" type="checkbox"/> ON: en ouverture n'inverse pas et n'arrête pas</li> <li><input type="checkbox"/> 2 OFF: en ouverture arrête et inverse toujours</li> <li><input checked="" type="checkbox"/> ON: pas-pas avec arrêt intermédiaire</li> <li><input type="checkbox"/> 5 OFF: inverse le mouvement à chaque impulsion radio</li> <li><input type="radio"/> <b>L7 éteinte</b> = aucun contact RADIO, elles'allume à chaque impulsion du contact radio</li> </ul>
<b>Sortie voyant de signalisation de 24 V max 3 W:</b>	<p>Sortie pour un éventuel voyant 24 V max 3 W pour la signalisation de l'état de l'automatation:</p> <p>Voyant <b>allumé</b> = portail ouvert  Voyant <b>éteint</b> = portail fermé  Clignotement <b>0,5 s (rapide)</b> = mouvement de fermeture  Clignotement <b>1 s (normal)</b> = mouvement d'ouverture</p>	

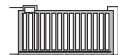

## LISTEAUX DE SECURITE

Les deux entrées dédiées aux listeaux sont séparés, l'un pour l'ouverture et l'autre pour la fermeture. Avec les deux pont de passage JA1 et JA2, on peut aussi choisir le type de contact connecté: mécanique NC ou résistif 8,2 kΩ.

Grâce à un microcontrôleur dédié aux listeaux sur la plaque, on vérifie constamment l'intégrité et la fonctionnalité du système de sécurité. Un possible défaut ou perte d'efficacité est signalé par le clignotement continu des LED L10 et L35.



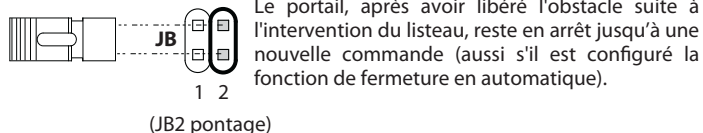
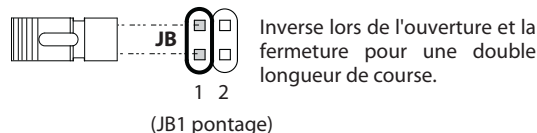
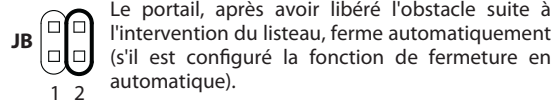
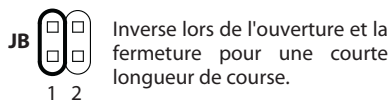

## Sélection du fonctionnement:

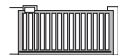

Accessoire	Raccordements électriques	LED de signalisation des différentes fonctions
<b>Listeau de sécurité en fermeture:</b> 	<p><i>En série si listeaux mécaniques NF</i></p> <p><i>En parallèle si listeaux résistifs 8,2 kΩ</i></p> <p><b>Sélection typologie de listeau utilisé:</b></p> <p>Listeau NF (JA1 pontage)</p> <p>Listeau résistif 8,2 kΩ</p>	<p><b>Normalement allumé:</b> lorsque il y a l'intervention du listeau, le voyant s'éteint</p>
<b>Listeau de sécurité en ouverture:</b> 	<p><i>En série si listeaux mécaniques NF</i></p> <p><i>En parallèle si listeaux résistifs 8,2 kΩ</i></p> <p><b>Sélection typologie de listeau utilisé:</b></p> <p>Listeau NF (JA2 pontage)</p> <p>Listeau résistif 8,2 kΩ</p>	<p><b>Normalement allumé:</b> lorsque il y a l'intervention du listeau, le voyant s'éteint</p>

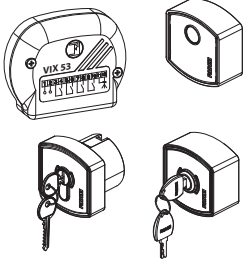
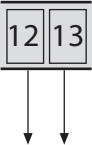
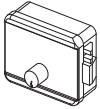
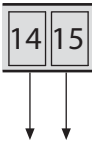

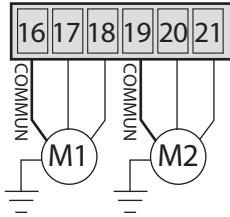
## RACCORDEMENTS ELECTRIQUES AUX BORNES POUR L'OUVERTURE COULISSANTE - dip-switch - B n° 1 = ON

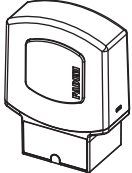
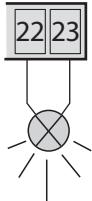
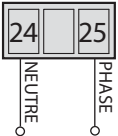
Accessoire	Raccordements électriques	Dip-Switch et LED de signalisation des différentes fonctions
<b>Sortie 24 Vac:</b> 	 <p>SORTIE 24 Vac pour charge max: n° 3 paires photocellules n° 1 récepteur radio n° 1 led sélecteur Chis 37 / Chis-E 37 <i>Toutes les notices d'instructions sont jointes aux respectifs accessoires de commande</i></p>	
<b>Serrure électrique:</b> 	 <p>Sortie alimentation 12 Vac/dc ou 24 Vac/dc pour <b>serrure électrique</b> 15 VA max</p> <p>"STRIP" PONTAGE</p> <p>LOCK SETUP 1 2 3 1 2 3</p> <p>Alimentation serrure électrique mécanique à déclic</p> <p>LOCK SETUP 1 2 3 1 2 3</p> <p>Alimentation serrure électrique magnétique de retenue sur la butée du portail</p> <p>AC = sortie à courant alternatif</p> <p>DC = sortie à courant continu</p>	 <p>TEMPS <b>SERRURE ELECTRIQUE</b> 0,5 s - 20 s</p> <p>12 V</p> <p>3 2 1</p> <p>Alimentation serrure électrique 12 V</p> <p>24 V</p> <p>3 2 1</p> <p>Alimentation serrure électrique 24 V</p>
<b>Sortie pour moteurs monophasés 230 V - 350 W max - 0,5 CV:</b>	<p><b>S'il y a seulement un moteur:</b></p> <ol style="list-style-type: none"> <li>Raccorder l'alimentation aux bornes du moteur M1</li> <li>Exclure le retard vantail à l'ouverture <b>dip-A n° 8 = ON</b></li> <li>Régler au minimum le trimmer de retard vantail en fermeture</li> </ol> <p><b>S'il y a n° 2 moteurs:</b></p> <ol style="list-style-type: none"> <li>Raccorder l'alimentation aux bornes du moteurs M1 et M2</li> <li>Exclure le retard vantail à l'ouverture <b>dip-A n° 8 = ON</b></li> <li>Régler au minimum le trimmer de retard vantail en fermeture</li> </ol> 	 <p>TEMPS DE <b>TRAVAIL</b> OUVRE-FERME 0 s - 120 s</p>  <p>TEMPS DE <b>PAUSE</b> 1 s - 220 s</p>
<b>Lampe clignotante 230 Vac:</b> 	 <p>SORTIE <b>230 Vac</b> pour lampe clignotante max 25 W</p>	<p><b>DIP-SWITCH - A N° 4 et N° 10:</b></p> <p><input checked="" type="checkbox"/> <b>ON:</b> pré-clignotement avant le mouvement</p> <p><input type="checkbox"/> <b>OFF:</b> sans pré-clignotement</p> <p>4</p> <p><input checked="" type="checkbox"/> <b>ON:</b> lampe clignotante désactivée pendant la pause en fonctionnement automatique (avec <b>dip 3 = ON</b>)</p> <p><input type="checkbox"/> <b>OFF:</b> clignote pendant la pause en fonctionnement automatique (avec <b>dip 3 = ON</b>)</p> <p>10</p>
<b>Alimentation carte 230 V:</b>	 <p><b>Alimentation programmeur</b> 230 V - 50/60 Hz ±10%</p> <p>NEUTRE PHASE</p>	



## RACCORDEMENTS ELECTRIQUES AUX BORNES POUR L'OUVERTURE COULISSANTE - dip-switch - B n° 1 = ON

Accessoire	Raccordements électriques	LED de signalisation des différentes fonctions
<b>Raccordement Pulin 3:</b> 	 Bornier pour le raccordement des Leds de la boîte à boutons poussoirs <b>Pulin 3</b>	
<b>Sortie 24 Vdc - 5 W:</b>	 SORTIE 24 Vdc - 5 W max	

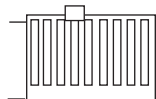
**Fin de course pour unique coulissant:**

S'il est utilisé seulement un moteur connecter les entrées du fin de course en "parallèle" entre M1 et M2 (faire pontage 30 avec 33 et 31 avec 34, et connecter avec fin de course ouvre - ferme).

**IMPORTANT:**

si les fins de course **ne sont pas utilisés**, faire un pontage entre les entrées 30 - 31 - 32 - 33 - 34. Utiliser Fc normalement fermé

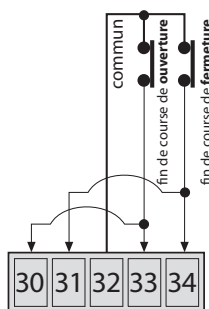

- L30 allumée** = éteinte à Fc Ouverture
- L31 allumée** = éteinte à Fc Fermeture
- L33 allumée** = éteinte à Fc Ouverture
- L34 allumée** = éteinte à Fc Fermeture

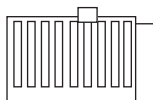
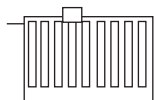
**Fin de course pour doubler coulissant:**

Si elles sont utilisées deux moteurs, connecter le fin de course normalement fermé aux entrées respectives.

**IMPORTANT:** si les fins de course **ne sont pas utilisés**, faire un pontage entre les entrées 30 - 31 - 32 - 33 - 34. Utiliser Fc normalement fermé

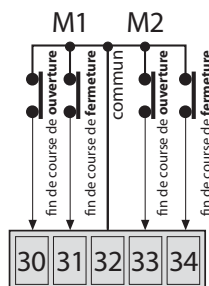

- L30 allumée** = éteinte à Fc Ouverture M1
- L31 allumée** = éteinte à Fc Fermeture M1
- L33 allumée** = éteinte à Fc Ouverture M2
- L34 allumée** = éteinte à Fc Fermeture M2

**Carte enfichable feu de circulation (optional - cod. 7282L):**

L'alimentation de la carte est indépendante de celle du programmeur: 230 V - 50 Hz avec sortie de 100 W à 230 V pour chaque ampoule.

**Logique de fonctionnement:**

- feu **VERT** = passage **OUVERT**
- feu **ROUGE** = passage **FERME**
- feu **JAUNE** = s'allume juste avant le passage du feu vert au feu rouge.

**Note:** lorsque le fonctionnement **piétons** est actif le feu reste **ROUGE**.

**Dip-switch - A**

- 4 = ON** Pré-clignotement actif: feu de circulation rouge - jaune - vert
- 4 = OFF** Pré-clignotement désactivé: feu de circulation rouge - jaune

**6 = ON** Fin de course installé

**6 = OFF** Fin de course pontage (temps de fonctionnement)

**Dip-Switch - B**

**3 = ON** Temps de pré-clignotement prolongé d'environ 2 secondes (la lumière jaune s'allume en 3 secondes)

**3 = OFF** Temps standard

**Fonctionnement avec 2 lampes (rouge et vert):**

- Dip-switch - A** **4 = OFF**
- Dip-switch - A** **6 =** ajuster la position en fonction de la présence ou l'absence de fin de course dans le système

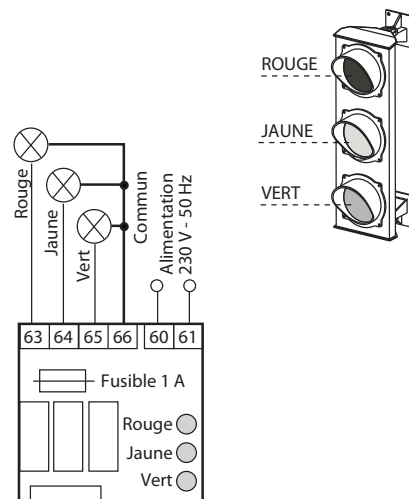

**Dip-Switch - B** **3 = OFF**

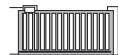

**(Optional):**  
carte enfichable pour feu de circulation lampe à 230 V)  
code **7282L**

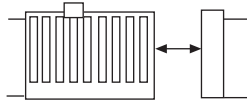

## FONCTIONS POUR L'OUVERTURE COULISSANTE - dip-switch - B n° 1 = ON

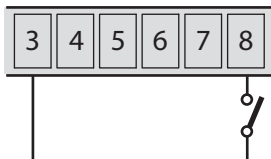
Description	Dip-switch et signalisation LED des différentes fonctions
<p><b>AUTOMATIQUE / SEMI-AUTOMATIQUE:</b>  <b>Cycle automatique:</b> à la commande ouvre, le portail s'ouvre et s'arrête en pause pour le temps mémorisé dans le <b>trimmer pause</b>. Expiré ce temps, le portail se referme automatiquement.  <b>Cycle semi-automatique:</b> à la commande ouvre, le portail s'ouvre et s'arrête en position d'ouverture. Pour la fermeture du passage, il faut donner l'impulsion de fermeture.</p>	<p><b>DIP-SWITCH - A N° 3:</b></p> <ul style="list-style-type: none"> <li><input checked="" type="checkbox"/> ON: ferme en automatique</li> <li><input type="checkbox"/> 3 OFF: semi-automatique</li> </ul> <p> <b>Trimmer pause:</b> on règle le temps de pause en modalité automatique de 1 s jusqu'à 220 s</p>
<p><b>OUVERTURE PIETONNE:</b>  L'ouverture piétonne avec portail fermé est possible à travers la commande sur contacts 3-8</p> <p>(On conseille l'utilisation de l'ouverture piétonne avec dip-A n° 3 = ON pour la refermeture automatique).</p> <p>La fonction <b>ouverture piétonne</b> n'est pas actif pendant le premier cycle de fonctionnement à la suite de l'absence de tension d'alimentation.</p>	<p> →</p> <p> <b>OUVERTURE PIETONNE</b> 1 s - 45 s</p> <p><input type="radio"/> <b>L8 éteinte</b> = aucun contact piéton s'allume à chaque commande ouverture piétonne</p> <p> <b>OUVERT PIETONS</b></p>
<p><b>REFERMURE AU PASSAGE DES PHOTOCELLES:</b>  <b>en phase d'ouverture et en pause (avec DIP-A N° 3 = ON)</b>  Fonction qui permet la refermeture automatique du portail après 3 s du passage à travers le faisceau des photocellules. Pour avoir la refermeture automatique lorsqu'il est installé la 2<sup>ème</sup> paire de photocellules (dip-9 = ON), il est nécessaire traverser le faisceau à la fois.</p>	<p><b>DIP-SWITCH - A N° 9 et N° 11:</b></p> <ul style="list-style-type: none"> <li><input checked="" type="checkbox"/> ON: activer la 2<sup>ème</sup> paire de photocellules</li> <li><input type="checkbox"/> 9 OFF: 2<sup>ème</sup> paire de photocellules pas utilisé</li> </ul> <ul style="list-style-type: none"> <li><input checked="" type="checkbox"/> ON: refermeture automatique après 3 secondes du passage des photocellules</li> <li><input type="checkbox"/> 11 OFF: aucune refermeture automatique du passage des photocellules</li> </ul>
<p><b>DSA:</b>  <b>CONTROLE AUTOMATIQUE DES PHOTOCELLES</b>  Pour le contrôle <b>DSA (Dispositif Sécurité Autotest)</b> il faut raccorder à cette sortie <b>seulement les projecteurs des photocellules</b> et il faut sélectionner le <b>dip-B n° 4 = ON</b>: avant chaque mouvement du portail, si cette fonction est en service, l'Elpro 27 contrôle que tous les dispositifs photocellules raccordés soient libres d'obstacles et correctement fonctionnants. En cas contraire le portail ne part pas.</p>	<p><b>DIP-SWITCH - B N° 4:</b></p> <ul style="list-style-type: none"> <li><input checked="" type="checkbox"/> ON: active le contrôle des <b>sécurités DSA</b></li> <li><input type="checkbox"/> 4 OFF: désactive le contrôle des <b>sécurités DSA</b></li> </ul>
<p><b>HOMME MORT:</b>  On obtient la commande d'ouverture et fermeture à <b>action maintenue</b> (sans autotenué dans les relais), donc il y a la présence active d'un opérateur pendant tout le mouvement de l'automation jusqu'à la relâche de la touche ou de la clé du sélecteur.</p>	<p><b>DIP-SWITCH - B N° 2:</b></p> <ul style="list-style-type: none"> <li><input checked="" type="checkbox"/> ON: active la fonction <b>homme mort</b></li> <li><input type="checkbox"/> 2 OFF: désactive la fonction <b>homme mort</b></li> </ul>
<p><b>PARTY FUNCTION</b>  <b>OUVERTURE PAR HORLOGE EXTERNE:</b>  <b>Raccordement:</b> raccorder en parallèle le contact NO de l'horloge avec la borne n° 4 OUVRE et n° 3 COMMUN, activant la refermeture automatique avec le dip-switch n° 3 = ON.  <b>Fonctionnement:</b> mémoriser l'heure d'ouverture dans l'horloge. A l'heure mémorisée le portail s'ouvre, en restant ouvert (la lampe clignotante s'éteint).  <b>Il n'acceptera plus aucune commande</b> (même radio) jusqu'à l'expiration du temps rentré dans l'horloge.  A l'expiration de ce temps, <b>après le temps de pause</b>, suivra la <b>fermeture automatique</b>. Pendant la pause à portail ouvert avec la commande <b>horloge</b>, le voyant de signalisation émet deux clignotements rapprochés suivis d'une pause plus longue.</p>	<p><b>DIP-SWITCH - A N° 3:</b></p> <ul style="list-style-type: none"> <li><input checked="" type="checkbox"/> ON: ferme en automatique</li> <li><input type="checkbox"/> 3</li> </ul> <p><b>IMPORTANT:</b>  <b>utiliser toujours et seulement avec le dip-A N° 3 = ON</b></p>



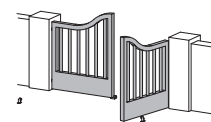
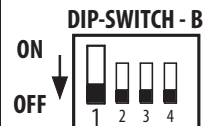

## POUR OUVRE-PORTAILS BATTANT: positionner le dip-switch - B n° 1 = OFF

**Dip-switch A**

- 1 = ON Photocellule arrête en ouverture
- 2 = ON Radio n'inverse pas en ouverture
- 3 = ON Ferme en automatique
- 4 = ON Pré-clignotement active
- 5 = ON Radio pas-pas
- 6 = ON Service feu de circulation avec fin de course connecté

- 7 = ON Coup de bélier en ouverture
- 8 = ON Elimine le retard vantail en ouverture, les moteurs partent ensemble
- 9 = ON Met en service l'entrée 2<sup>ème</sup> paire photocellules
- 10 = ON Lampe clignotante éteinte en pause
- 11 = ON Referme en ouverture et en pause après le passage des photocellules
- 12 = ON Mémoire des temps active pour des installations à haute fréquence de travail

**DIP-SWITCH - A****Dip-switch B**

- 1 = OFF Modalité **OUVRE-PORTAIL BATTANT**
- 2 = ON Homme mort
- 3 = ON Feu de circulation avec "jaune" pour 3 secondes
- 4 = ON Contrôle DSA projecteurs photocellules si raccordés aux bornes dédiées

**DIP-SWITCH - B**

## RACCORDEMENTS ELECTRIQUES AUX BORNES POUR L'OUVERTURE A BATTANT - dip-switch - B n° 1 = OFF

Accessoire	Raccordements électriques	Dip-switch et LED de signalisation des différentes fonctions
<b>2<sup>ème</sup> paire de photocellules (installées à l'interne):</b> 	<p>Cette paire de photocellules s'arrête à l'ouverture; lorsqu'il est enlevé l'obstacle, le portail continue pour ouvrir, dans la phase de fermeture inverse le sens.</p> <p>Avec <b>dip-A n° 9 = ON</b> et l'entrée <b>NF</b> raccordée: le portail reste en position arrêtée pour aussi long temps que les photocellules sont engagées.</p> <ul style="list-style-type: none"> <li>- En phase d'ouverture: avec obstacle enlevé, recommence l'ouverture</li> <li>- En phase de fermeture: avec obstacle enlevé, inverse le mouvement</li> </ul> <p><b>NOTE: s'il n'y a pas l'obstacle, il n'est pas nécessaire raccorder l'entrée du contact, laissant seulement le dip-A n° 9 = OFF</b></p>	<b>DIP-SWITCH - A N° 9:</b> <ul style="list-style-type: none"> <li><input checked="" type="checkbox"/> ON: met en service la 2<sup>ème</sup> paire photocellules</li> <li><input type="checkbox"/> OFF: 2<sup>ème</sup> paire photocellules pas utilisée</li> </ul> <p> <b>L0 allumée</b> = aucun obstacle, elle s'éteint avec la présence de l'obstacle</p>
<b>1<sup>ère</sup> paire de photocellules: (installées à l'externe):</b> 	<p><b>Sortie 24 Vac</b> charge max: n° 1 récepteur radio n° 3 paires photocellules</p> <p>Tous les contacts NF des accessoires de sécurité comme les Photocellules (récepteurs) doivent être raccordés en série aux bornes 1 et 2</p>	<b>DIP-SWITCH - A N° 1:</b> <ul style="list-style-type: none"> <li><input checked="" type="checkbox"/> ON: arrête en ouverture et inverse en fermeture avec l'obstacle enlevé</li> <li><input type="checkbox"/> OFF: n'arrête pas en ouverture et inverse en fermeture avec la présence de l'obstacle</li> </ul> <p> <b>L1 allumée</b> = aucun obstacle, elle s'éteint avec la présence de l'obstacle</p>
<b>Sélecteur à clé:</b> 	<p>Contacts NO et NF à raccorder aux respectives bornes des sélecteurs ou des boîtes à boutons poussoirs. Toutes les possibles configurations sont jointes aux respectifs accessoires de commande.</p>	<ul style="list-style-type: none"> <li><input type="checkbox"/> <b>L4 éteinte</b> = aucun contact OUVRE, elle s'allume à chaque impulsion d'ouverture</li> <li><input type="checkbox"/> <b>L5 éteinte</b> = aucun contact FERME, elle s'allume à chaque impulsion de fermeture</li> <li> <b>L6 allumée</b> = contact d'ARRET fermé, elle s'éteint à chaque contact d'arrêt</li> </ul>
<b>Contact radio (avec fonction pas-pas):</b> 	<p>Raccordant un contact NO entre les deux bornes on peut obtenir à chaque impulsion:</p> <ul style="list-style-type: none"> <li>- Seulement ouverture: <b>dip 2 = ON</b> et <b>dip 5 = OFF</b></li> <li>- Inversion de marche à chaque impulsion <b>dip 2 = OFF</b> et <b>dip 5 = OFF</b></li> <li>- Pas-pas: ouvre-arrêt-ferme-arrêt <b>dip 2 = OFF</b> et <b>dip 5 = ON</b></li> <li>- En phase d'ouverture il n'accepte aucune commande. En pause et en fermeture, à chaque commande, il exécute l'arrêt avec l'inversion de marche: <b>dip 2 = ON</b> et <b>dip 5 = ON</b></li> </ul>	<b>DIP-SWITCH - A N° 2 et N° 5:</b> <ul style="list-style-type: none"> <li><input checked="" type="checkbox"/> ON: en ouverture n'inverse pas et n'arrête pas</li> <li><input type="checkbox"/> OFF: en ouverture arrête et inverse toujours</li> </ul> <ul style="list-style-type: none"> <li><input checked="" type="checkbox"/> ON: pas-pas avec arrêt intermédiaire</li> <li><input type="checkbox"/> OFF: inverse le mouvement à chaque impulsion radio</li> <li><input type="checkbox"/> <b>L7 éteinte</b> = aucun contact RADIO, elles'allume à chaque impulsion du contact radio</li> </ul>
<b>Sortie voyant de signalisation de 24 V max 3 W:</b>	<p>Sortie pour un éventuel voyant 24 V max 3 W pour la signalisation de l'état de l'automatisme:  Voyant <b>allumé</b> = portail ouvert  Voyant <b>éteint</b> = portail fermé  Clignotement <b>0,5 s (rapide)</b> = mouvement de fermeture  Clignotement <b>1 s (normal)</b> = mouvement d'ouverture</p>	



## LISTEAUX DE SECURITE

Les deux entrées dédiées aux listeaux sont séparés, l'un pour l'ouverture et l'autre pour la fermeture. Avec les deux pont de passage JA1 et JA2, on peut aussi choisir le type de contact connecté: mécanique NC ou résistif 8,2 kΩ.  
Grâce à un microcontrôleur dédié aux listeaux sur la plaque, on vérifie constamment l'intégrité et la fonctionnalité du système de sécurité. Un possible défaut ou perte d'efficacité est signalé par le clignotement continu des LED L10 et L35.

## Sélection du fonctionnement:

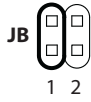

Inverse lors de l'ouverture et la fermeture pour une courte longueur de course.

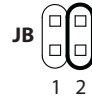

Le portail, après avoir libéré l'obstacle suite à l'intervention du listeau, ferme automatiquement (s'il est configuré la fonction de fermeture en automatique).

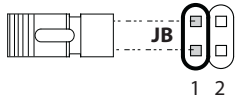

(JB1 pontage)

Inverse lors de l'ouverture et la fermeture pour une double longueur de course.

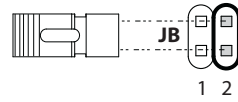

(JB2 pontage)

Le portail, après avoir libéré l'obstacle suite à l'intervention du listeau, reste en arrêt jusqu'à une nouvelle commande (aussi s'il est configuré la fonction de fermeture en automatique).

## Accessoire

## Raccordements électriques

## LED de signalisation des différentes fonctions

## Listeau de sécurité en fermeture:

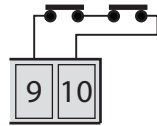
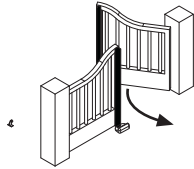

En série si  
listeaux mécaniques NF

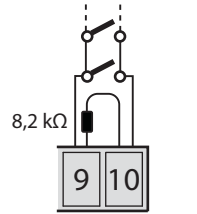

En parallèle si  
listeaux résistifs 8,2 kΩ



**Normalement allumé:**  
lorsque il y a l'intervention du listeau,  
le voyant s'éteint

## Sélection typologie de listeau utilisé:

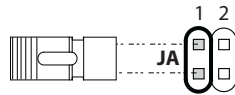

Listeau NF  
(JA1 pontage)



Listeau résistif 8,2 kΩ

## Listeau de sécurité en ouverture:

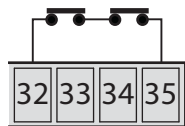
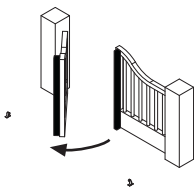

En série si  
listeaux mécaniques NF

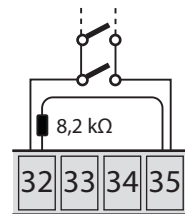

En parallèle si  
listeaux résistifs 8,2 kΩ



**Normalement allumé:**  
lorsque il y a l'intervention du listeau,  
le voyant s'éteint

## Sélection typologie de listeau utilisé:

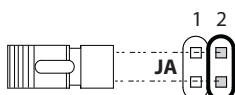

Listeau NF  
(JA2 pontage)



Listeau résistif 8,2 kΩ







## RACCORDEMENTS ELECTRIQUES AUX BORNES POUR L'OUVERTURE A BATTANT - dip-switch - B n° 1 = OFF

Accessoire	Raccordements électriques	Dip-switch et LED de signalisation des différentes fonctions
<b>Sortie 24 Vac:</b> 	<p>SORTIE 24 Vac pour charge max: n° 3 paires photocellules n° 1 récepteur radio n° 1 led sélecteur Chis 37 / Chis-E 37</p> <p>Toutes les notices d'instructions sont jointes aux respectifs accessoires de commande</p>	
<b>Serrure électrique:</b> 	<p>Sortie alimentation 12 Vac/dc ou 24 Vac/dc pour serrure électrique 15 VA max. Installer la serrure électrique sur le vantail du moteur M1 avec fermeture retardée.</p> <p>"STRIP" PONTAGE</p> <p>LOCK SETUP 3 2 1 Alimentation serrure électrique mécanique à déclic</p> <p>LOCK SETUP 3 2 1 Alimentation serrure électrique magnétique de retenue sur la butée du portail</p> <p>AC = sortie à courant alternatif</p> <p>DC = sortie à courant continu</p>	<p>TEMPS SERRURE ELECTRIQUE 0,5 s - 20 s</p> <p>12 V 3 2 1 Alimentation serrure électrique 12 V</p> <p>24 V 3 2 1 Alimentation serrure électrique 24 V</p>
<b>Sortie pour moteurs monophasés 230 V - 350 W max - 0,5 CV:</b>	<p><b>S'il y a seulement un moteur:</b></p> <ol style="list-style-type: none"> <li>Raccorder l'alimentation aux bornes du moteur M1</li> <li>Exclure le retard vantail à l'ouverture <b>dip-A n° 8 = ON</b></li> <li>Régler au minimum le trimmer de retard vantail en fermeture</li> </ol> <p><b>S'il y a n° 2 moteurs:</b></p> <p>Le retard vantail à l'ouverture est fixe à 2 s. Si nécessaire il doit être activé avec le <b>dip-A n° 8 = OFF</b></p>	<p>TEMPS DE TRAVAIL OUVRE-FERME 0 s - 60 s</p> <p>TEMPS DE PAUSE 1 s - 220 s</p> <p>RETARD VANTAIL EN FERMETURE 0 s - 10 s</p> <p><b>DIP-SWITCH - A N° 8:</b></p> <p><input type="checkbox"/> ON: elimine le retard vantail en ouverture</p> <p><input type="checkbox"/> 8 OFF: active le retard vantail de 2 s en ouverture</p>
<b>Verrou électrique et lampe clignotante 230 Vac:</b> 	<p>SORTIE 230 Vac pour verrou électrique: <b>il est toujours important couper l'alimentation pendant la pause avec dip-A n° 10 = ON</b></p> <p>SORTIE 230 Vac pour lampe clignotante max 25 W</p>	<p><b>DIP-SWITCH - A N° 4 et N° 10:</b></p> <p><input type="checkbox"/> ON: pré-clignotement avant le mouvement</p> <p><input type="checkbox"/> 4 OFF: sans pré-clignotement</p> <p><input type="checkbox"/> ON: désactivé pendant la pause en fonctionnement automatique (avec <b>dip 3 = ON</b>)</p> <p><input type="checkbox"/> 10 OFF: alimentation présente pendant la pause en fonctionnement automatique (avec <b>dip 3 = ON</b>)</p>
<b>Alimentation carte 230 V:</b>	<p>Alimentation programmeur 230 V - 50/60 Hz ± 10%</p> <p>NEUTRE PHASE</p>	

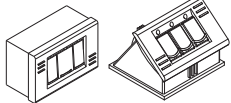
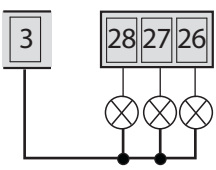

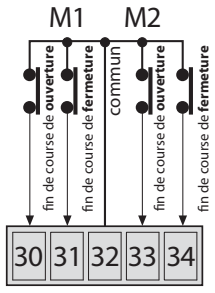
## RACCORDEMENTS ELECTRIQUES AUX BORNES POUR L'OUVERTURE A BATTANT - dip-switch - B n° 1 = OFF

Accessoire	Raccordements électriques	LED de signalisation des différentes fonctions
<b>Alimentation led Pulin 3:</b> 	 <p>Bornier pour le raccordement des Leds de la boîte à boutons poussoirs <b>Pulin 3</b></p>	
<b>Sortie 24 Vdc - 5 W:</b>	 <p>SORTIE 24 Vdc - 5 W max</p>	
<b>Fin de course:</b>	<p><b>IMPORTANT:</b> si les fins de course <b>ne sont pas utilisés</b>, faire un pontage entre les entrées 30 - 31 - 32 - 33 - 34. Utiliser Fc. normalement fermé</p> 	 <p><b>L30 allumée</b> = éteinte à Fc Ouverture M1</p> <p><b>L31 allumée</b> = éteinte à Fc Fermeture M1</p> <p><b>L33 allumée</b> = éteinte à Fc Ouverture M2</p> <p><b>L34 allumée</b> = éteinte à Fc Fermeture M2</p>

**Carte enfichable feu de circulation (optional - cod. 7282L):**

L'alimentation de la carte est indépendante de celle du programmateur: 230 V - 50 Hz avec sortie de 100 W à 230 V pour chaque ampoule.

**Logique de fonctionnement:**

- feu **VERT** = passage **OUVERT**
- feu **ROUGE** = passage **FERME**
- feu **JAUNE** = s'allume juste avant le passage du feu vert au feu rouge.

**Note:** lorsque le fonctionnement **piétons** est actif le feu reste **ROUGE**.

**Dip-switch - A**

- 4 = ON** Pré-clignotement actif: feu de circulation rouge - jaune - vert
- 4 = OFF** Pré-clignotement désactivé: feu de circulation rouge - jaune

**6 = ON** Fin de course installé

**6 = OFF** Fin de course pontage (temps de fonctionnement)

**Dip-Switch - B**

**3 = ON** Temps de pré-clignotement prolongé d'environ 2 secondes (la lumière jaune s'allume en 3 secondes)

**3 = OFF** Temps standard

**Fonctionnement avec 2 lampes (rouge et vert):**

**Dip-switch - A**

**4 = OFF**

**Dip-switch - A**

**6 =** ajuster la position en fonction de la présence ou l'absence de fin de course dans le système

**Dip-Switch - B**

**3 = OFF**

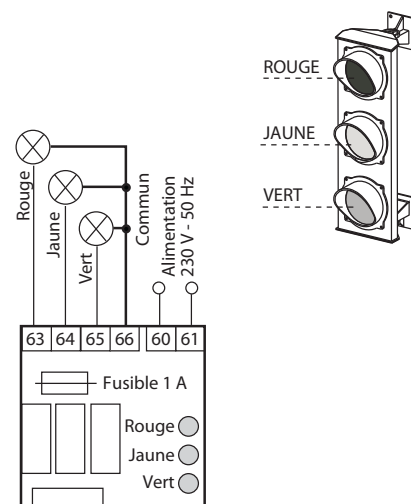
**(Optional):**

carte enfichable pour feu de circulation lampe à 230 V)  
**code 7282L**



## FONCTIONS POUR L'OUVERTURE A BATTENT - dip-switch - B n° 1 = OFF

## Description

## Dip-switch et signalisation LED des différentes fonctions

**AUTOMATIQUE / SEMI-AUTOMATIQUE:**

**Cycle automatique:** à la commande ouvre, le portail s'ouvre et s'arrête en pause pour le temps mémorisé dans le **trimmer pause**. Expiré ce temps, le portail se referme automatiquement.

**Cycle semi-automatique:** à la commande ouvre, le portail s'ouvre et s'arrête en position d'ouverture. Pour la fermeture du passage, il faut donner l'impulsion de fermeture.

**DIP-SWITCH - A N° 3:**

- ON:** ferme en automatique
- OFF:** semi-automatique



**Trimmer pause:** on règle le temps de pause en modalité automatique de 1 s jusqu'à 220 s

**OUVERTURE PIETONNE SEULEMENT POUR LE MOTEUR M1:**

L'ouverture piétonne avec portail fermé est possible à travers la commande sur contacts 3-8

(On conseille l'utilisation de l'ouverture piétonne avec dip-A n° 3 = ON pour la refermeture automatique).

La fonction **ouverture piétonne** n'est pas actif pendant le premier cycle de fonctionnement à la suite de l'absence de tension d'alimentation.

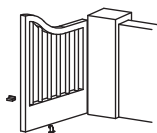

- L8 éteinte** = aucun contact piéton s'allume à chaque commande ouverture piétonne

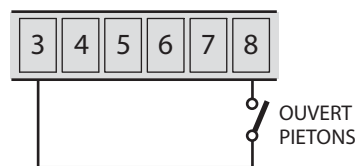
**REFERMURE AU PASSAGE DES PHOTOCELLES: en phase d'ouverture et en pause (avec DIP-A N° 3 = ON)**

Fonction qui permet la refermeture automatique du portail après 3 s du passage à travers le faisceau des photocellules. Pour avoir la refermeture automatique lorsqu'il est installé la 2<sup>ème</sup> paire de photocellules (dip-9 = ON), il est nécessaire traverser le faisceau à la fois.

**DIP-SWITCH - A N° 9 et N° 11:**

- ON:** activer la 2<sup>ème</sup> paire de photocellules
- OFF:** 2<sup>ème</sup> paire de photocellules pas utilisé

- ON:** refermeture automatique après 3 secondes du passage des photocellules
- OFF:** aucune refermeture automatique du passage des photocellules

**DSA: CONTROLE AUTOMATIQUE DES PHOTOCELLES**

Pour le contrôle **DSA (Dispositif Sécurité Autotest)** il faut raccorder à cette sortie **seulement les projecteurs des photocellules** et il faut sélectionner le **dip-B n° 4 = ON**: avant chaque mouvement du portail, si cette fonction est en service, l'Elpro 27 contrôle que tous les dispositifs photocellules raccordés soient libres d'obstacles et correctement fonctionnants. En cas contraire le portail ne part pas.

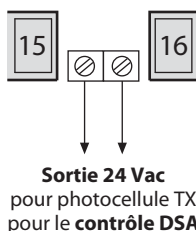
**DIP-SWITCH - B N° 4:**

- ON:** active le contrôle des **sécurités DSA**
- OFF:** désactive le contrôle des **sécurités DSA**

**HOMME MORT:**

On obtient la commande d'ouverture et fermeture à **action maintenue** (sans autotenué dans les relais), donc il y a la présence active d'un opérateur pendant tout le mouvement de l'automatisme jusqu'à la relâche de la touche ou de la clé du sélecteur.

**DIP-SWITCH - B N° 2:**

- ON:** active la fonction **homme mort**
- OFF:** désactive la fonction **homme mort**

**COUP DE BELIER EN OUVERTURE:**

Fonction pour faciliter le désengagement de la serrure électrique à portail complètement fermée, aussi en mode **ouverture piétonne**: les vantaux du portail fermé, avant d'ouvrir sont obligés de fermer pour **2 secondes**.

**DIP-SWITCH - A N° 7:**

- ON:** activer le coup de belier en ouverture pour 2 s
- OFF:** désactiver la fonction coup de belier

**UTILISATION DE CONDOMINIUM:**

Fonction pour utilisations hautement intensive avec de fréquents changements de direction: si cette fonction est activée prend en compte le temps restant de travail quand il y a un demi-tour ou une étape sur les photocellules.

**DIP-SWITCH - A N° 12:**

- ON:** mémoire du temps de travail active
- OFF:** fonctionnement normal sans mémoire

**PARTY FUNCTION****OUVERTURE PAR HORLOGE EXTERNE:**

**Raccordement:** raccorder en parallèle le contact NO de l'horloge avec la borne n° 4 OUVRE et n° 3 COMMUN, activant la refermeture automatique avec le dip-switch n° 3 = ON. **Fonctionnement:** mémoriser l'heure d'ouverture dans l'horloge. A l'heure mémorisée le portail s'ouvre, en restant ouvert (la lampe clignotante s'éteint). **Il n'acceptera plus aucune commande** (même radio) jusqu'à l'expiration du temps rentré dans l'horloge. A l'expiration de ce temps, **après le temps de pause**, suivra la fermeture automatique. Pendant la pause à portail ouvert avec la commande **horloge**, le voyant de signalisation émet deux clignotements rapprochés suivis d'une pause plus longue.

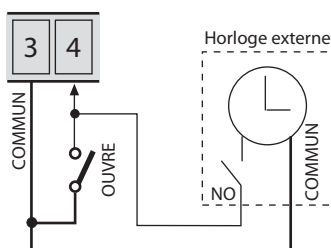
**DIP-SWITCH - A N° 3:**

- ON:** ferme en automatique
- OFF:** semi-automatique

**IMPORTANT:**

**utiliser toujours et seulement avec le dip-A N° 3 = ON**



**ALLGEMEINE HINWEISE FÜR DIE SICHERHEIT VON PERSONEN****DANKE**

Danken, dass Sie sich für ein Fadini Produkt entschieden haben. Bitte lesen Sie diese Gebrauchsanleitung sehr sorgfältig bevor Sie das Gerät in Betrieb nehmen. Sie enthält wichtige Informationen, damit Sie viel Freude an Ihrem Gerät haben und ein sicherer und sauberer Betrieb gewährleistet ist. Bewahren Sie dieses Handbuch gut auf, damit Sie bei Bedarf immer wieder darauf zurückgreifen können.

**EINFÜHRUNG**

Diese Automation ist ausschließlich für den in dieser Betriebsanleitung angegebenen Verwendungszweck entwickelt worden, mit den mindesten erforderlichen Sicherheitszubehörenden, dem Bedien- und Signalisierungszubehör und Fadini Vorrichtungen. □ Jede beliebige andere Anwendung, die nicht extra in diesem Handbuch angegeben worden ist, könnte zu Funktionsstörungen und Schäden an Dingen und Personen führen □ Meccanica Fadini S.r.l. ist nicht für eventuelle Schäden verantwortlich, die durch nicht gerechte und nicht spezifisch in diesem Handbuch angegebene Verwendung verursacht werden und haftet außerdem nicht für Betriebsstörungen, die durch die Verwendung von Materialien oder Zubehörenden, die nicht von der Firma selbst angegeben worden sind, entstanden sind. □ Die Herstellerfirma behält sich Änderungen an eigenen Produkten ohne Vorankündigung vor □ Alles, was nicht ausdrücklich in dieser Anleitung angegeben ist, ist nicht erlaubt.

**VOR DER INSTALLATION**

Vor jedem Eingriff ist die Eignung des zu automatisierenden Eingangs zu beurteilen, sowie dessen Zustand und Struktur. □ Stellen Sie sicher, dass es keine Situationen zum Aufprall, Zerkleinern, Scheren, Schleppen, Schneiden, Einhaken und Heben entstehen, die die Sicherheit von Personen gefährden können. □ Dieses Produkt nicht in der Nähe von Wärmequellen installieren und der Kontakt mit brennbaren Stoffen vermeiden. □ Alle Geräte (Sender, Proximity-Leser, Schalter, etc.) dürfen nicht in die Hände von Kindern gelassen werden. □ Übergang ist nur bei der gestoppten Automation erlaubt □ Lassen Sie nicht Kinder und / oder Erwachsene, um in der Nähe der Anlage mit der Automatisierung in Bewegung stehen. □ Um ein angemessenes Sicherheitsniveau der Anlage zu gewährleisten ist notwendig, um die Art der Installationbedienung zu identifizieren und dann im Zusammenhang mit dem Endkunden zu setzen; dann Lichtschranken, Kontaktleisten, Magnetspulen und Präsenzsensoren verwenden, um das gesamte betroffene Gebiet, um die Bewegung des Tors (besonders die Ränder der Flügel in Bewegung) gefahrlos zu machen. □ Verwenden Sie gelb-schwarze Streifen oder entsprechende Signale, um die Gefahrenstellen der Installation zu identifizieren. □ Die Spannung an das System abschalten, wenn Wartung und / oder Reinigung durchzuführen sind. □ Wird der Antrieb entfernt, die Drähte nicht schneiden, aber entfernen Sie sie aus dem Klemmenblock durch Lösen der Schrauben im Anschlusskasten.

**INSTALLATION**

Die gesamte Installation muss von qualifiziertem technischen Personal unter Einhaltung der Maschinenrichtlinie 2006/42/CE und besonders der Normen EN 12445 und EN 12453 durchgeführt werden. □ Überprüfen Sie die Anwesenheit aufwärts der Anlage, eines Magnetohermischen Differentialhauptschalter 230 V - 50 Hz 0,03 A □ Verwenden Sie Testkörper für die Funktionsprüfung in der Erfassung der Gegenwart, in der Nähe von Sicherheitseinrichtungen wie Lichtschranken, Sicherheitsleisten, etc.. □ Führen Sie eine sorgfältige Risikoanalyse unter Verwendung geeigneter Instrumenten zur Erkennung von Schlag- und Druck der Vorderkante des Öffnen und Schließen, wie in EN 12445 festgelegt. □ Identifizieren Sie die beste Lösung zur Beseitigung oder Verringerung dieser Risiken. □ In dem Fall, wo das Tor zu automatisieren wurde mit einem Fußgänger-Eingang ausgestattet, ist es zweckmäßig, das System in einer Weise herzustellen, um den Betrieb des Motors zu verhindern, wenn der Fußgänger-Eingang verwendet wird. □ Die Anwesenheit der Automation mit der Anwendung am Tor eines Warnschilds mit CE-Kennzeichnung ist zu signalisieren. □ Das Installateur wird benötigt, um über die richtige Nutzung des Systems Information und Aufklärung dem Endkunden zu geben; Layout und Komponenten des Systems, Risikoanalyse, Überprüfung der Sicherheitsausrüstung, Überprüfung der Aufprallkräfte und Berichterstattung von Restrisiken: dies wird durch die Gewährung von ihm einer signierten Dokumentation definierten technischen Dossiers getan.

**HINWEISE FÜR ENDBENUTZER**

Der Endbenutzer ist verpflichtet, Informationen nur über den Betrieb des Systems zu empfangen und zu lesen und wird sich für die korrekte Verwendung verantwortlich. □ Er muss einen Vertrag für ordentliche und außerordentliche Wartung (auf Abruf) mit dem Installateur / Betreuer schließen. □ Eine Reparatur darf nur von qualifiziertem Fachpersonal durchgeführt werden. □ Halten Sie diese Bedienungsanleitung.

**HINWEISE UM DEN EINWANDFREIEN BETRIEB DES SYSTEMS**

Für eine langfristig optimale Leistung der Anlage entsprechend den Sicherheitsnormen ist es notwendig die gesamte Anlage durch qualifiziertes Personal korrekt zu warten und zu kontrollieren, sowohl was die Automation als auch die installierten elektronischen Geräte und deren Verkabelungen betrifft. □ Die gesamte Anlage muss von qualifizierten Technikern durchgeführt werden, wobei das Dokument zur Überprüfung und zum Test und das im Handbuch Sicherheitsbestimmungen gezeigt Wartungsprotokoll auszufüllen sind (auf Anfrage oder von der Website [www.fadini.net/support/downloads](http://www.fadini.net/support/downloads) heruntergeladen). □ Für die Automatisierung wird empfohlen, eine Wartungsprüfung mindestens alle 6 Monate, während für elektronische Geräte und Sicherheitssysteme eine monatliche Wartung. □ Meccanica Fadini S.r.l. haftet nicht für die Nichteinhaltung der regelgerechten Installationstechnik und/oder unsachgemäße Wartung des Systems.

**ENTSORGUNG VON MATERIALIEN**

Verpackungsmaterial wie Pappe, Kunststoff, Polystyrol, etc.. kann durch die getrennte Sammlung entsorgt werden (nach Prüfung der geltenden Bestimmungen am Ort der Installation im Bereich der Abfallbeseitigung). Elektrischen, elektronischen Elements und Batterien können Schadstoffe enthalten: Entfernen und anvertrauen diese Komponenten an Unternehmen, die bei der Verwertung von Abfällen spezialisiert sind, wie in der Richtlinie 2012/19/UE festgelegt. Es ist verboten, umweltschädliche Materialien in den Hausmüll zu werfen.

**EU-KONFORMITÄTSERKLÄRUNG**

Hersteller: Meccanica Fadini S.r.l.  
Adresse: Via Mantova, 177/A - 37053 Cerea - VR - Italy

erklärt auf eigene Verantwortung, dass das Produkt:

Steuerzentrale Modell **ELPRO 27**

es erfüllt die einschlägigen Harmonisierungsrechtsvorschriften der Union:

- Richtlinie über Elektromagnetische Verträglichkeit 2014/30/UE  
- Niederspannungsrichtlinie 2014/35/UE

Cerea, 19/04/2017

Meccanica Fadini S.r.l.  
Betriebsleiter





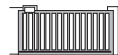

## FÜR SCHIEBETORANTRIEBE MIT ENDSCHALTERN:

Dip Schalter B Nr.1 = ON setzen

## DIP-SCHALTER - B

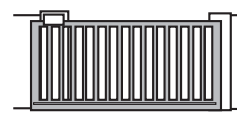

## Dip-Schalter A

- 1 = ON Lichtschanke stoppt b.Öffnung  
 2 = ON Funk.Kein Umkehr b.Öffnung  
 3 = ON Automatische Schliessung  
 4 = ON Vorblinken aktiv  
 5 = ON Funkkontakt. Schrittweise  
 6 = ON Service mit Ampel  
 mit angeschlossenen Endschaltern

- 7 = OFF: frei  
 8 = OFF: frei  
 9 = ON 2. Lichtschanke angeschlossen  
 10 = ON Blinkleuchte aus bei der Pause  
 11 = ON Wiederschliessen während der Öffnung und der Pause  
 wenn die Lichtschanke unterbrochen wird  
 12 = OFF: frei

## DIP-SCHALTER - A



## Dip-Schalter B

- 1 = ON SCHIEBETORANTRIEB Modus  
 2 = ON Totmann-Betrieb  
 3 = ON Ampel auf "gelb" 3 Sekunden lang  
 4 = ON DSA Kontrolle durch die Lichtsender, wenn sie an die dedizierten Klemmen angeschlossen sind

## DIP-SCHALTER - B



## ELEKTROANSCHLÜSSE AN DIE KLEMMEN BEI SCHIEBETOR-MODUS - Dip Schalter B Nr.1 = ON

Zubehör	Elektroanschlüsse	Dip-Schalter u. LED-Anzeige der verschiedenen Funktionen
<b>2. Lichtschanke (innerlich montiert):</b> 	 Diese Lichtschanke stoppt während der Öffnung; nach Entfernung des Hindernisses öffnet das Tor weiter, beim Schliessen kehrt das Tor um. <b>Dip-A Nr.9 = ON und der NC Ausgang angeschlossen:</b> das Torbleibt stehen solange die Lichtschanke engagiert ist. - Beim Öffnen: nach Entfernung des Hindernisses öffnet das Tor weiter - Beim Schließen: nach Entfernung des Hindernisses kehrt das Tor um <b>HINWEIS: den Kontakt-Eingang nicht überbrücken, wenn keine 2.Lichtschanke vorhanden ist, nur Dip-A Nr. 9 = OFF lassen</b>	<b>DIP-SCHALTER-A Nr. 9:</b>   <b>L0 An</b> = kein Hindernis vorhanden; sie erlischt bei vorhandenem Hindernis
<b>1. Lichtschanke (äusserlich montiert):</b> 	 <b>Ausgang 24 Vac max Belastung:</b> 1 Funkempfänger 3 Lichtschranken Alle NC-Kontakte des Sicherheitszubehörs, wie Lichtschanke (Lichtempfänger), müssen an die Klemmen 1 und 2 in Serie geschaltet werden	<b>DIP-SCHALTER-A Nr. 1:</b>  <b>L1 An</b> = kein Hindernis vorhanden; sie erlischt bei vorhandenem Hindernis
<b>Schlüsselschalter:</b> 	 NO und NC - Kontakte an die entsprechenden Klemmen der Schlüsselschalter oder der Drucktaster anzuschliessen. Die mögliche Konfigurationen sind den jeweiligen Bedienungszubehör beigelegt.	 <b>L4 Aus</b> = kein Kontakt ÖFFNUNG, sie leuchtet bei jeder Öffnungsimpuls-gabe  <b>L5 Aus</b> = kein Kontakt SCHLIES-SUNG, sie leuchtet bei jeder Schliessungs-kontakt  <b>L6 An</b> = STOP-Kontakt geschlossen, sie erlischt bei jeder Stop-Impuls-gabe
<b>Funkkontakt (bei schrittweiser Funktion):</b> 	 Wird jeder beliebige NO Kontakt zwischen der zwei Klemmen angeschlossen, ist folgendes bei jeder Impuls-gabe möglich: - Nur Öffnung: <b>dip 2 = ON u. dip 5 = OFF</b> - Richtungsumkehr bei jeder Impuls-gabe <b>dip 2 = OFF u. dip 5 = OFF</b> - Schrittweise: Öffnen-Stop-Schliessen-Stop <b>dip 2 = OFF u. dip 5 = ON</b> - Während der Öffnung wird kein Befehl akzeptiert. Bei der Pause und beim Schliessen jede Impuls-gabe stoppt und kehrt die Laufrichtung um: <b>dip 2 = ON u. dip 5 = ON</b>	<b>DIP-SCHALTER-A Nr. 2 u. Nr. 5:</b>   <b>L7 Aus</b> = kein FUNKkontakt, sie leuchtet bei jeder Funkimpuls-gabe
<b>Anzeigelicht Ausgang 24 V - max 3 W:</b>	 Ausgang für ein eventuelles Anzeigelicht 24 V max 3 W des Automation-Status: Licht <b>An</b> = offenes Tor Licht <b>Aus</b> = geschlossenes Tor Blinken <b>0,5 s (schnell)</b> = Schliessbewegung Blinken <b>1 s (standard)</b> = Öffnungsbewegung	

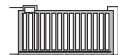

## SCHALTLEISTEN



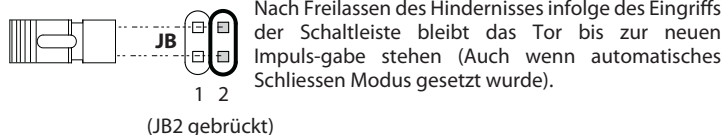
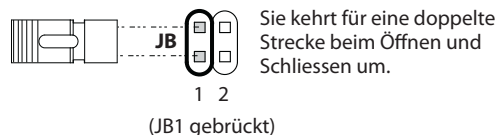
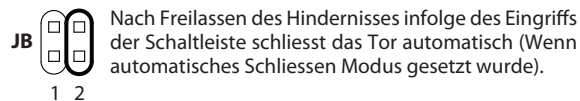
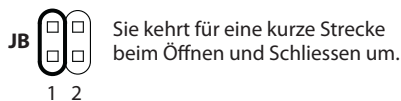



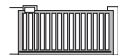



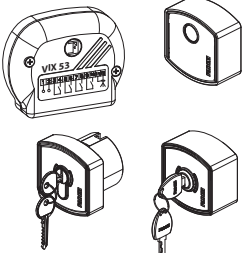

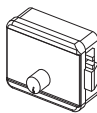

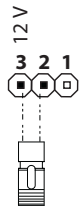
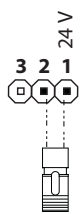
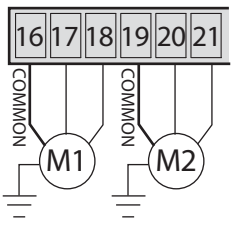
Die zwei Eingänge, vorgesehen zum Anschluß der Schaltleisten, sind für die Öffnungs- und Schließungsphase getrennt. Außerdem kann man die Art des angeschlossenen Kontakts auswählen, entweder mechanisch NC oder resistiv 8,2 k $\Omega$  mittels der zwei Überbrückungen JA1 und JA2. Dank einer dedizierten Mikrokontroller, auf der Karte eingesteckt, wird die tatsächliche Integrität und perfekte Funktionalität des Sicherheitssystems ständig überwacht. Eventuelle Fehler oder Effizienzverlust werden durch Blinken der L10 und L35 LEDs signalisiert.

**Betriebseinsetzung:**

Zubehör	Elektroanschlüsse	LED-Anzeige der verschiedenen Funktionen
<p><b>Schaltleiste bei der Schließung:</b></p>	<p><i>In Serie geschaltet bei NC mechanischen Schaltleisten</i></p> <p><i>Parallel geschaltet bei resistiven Schaltleisten 8,2 k<math>\Omega</math></i></p> <p><b>Verwendete Schaltleiste Typ wählen:</b></p> <p>Schaltleiste NC (JA1 gebrückt)</p> <p>Resistive Schaltleiste 8,2 k<math>\Omega</math></p>	<p><b>Normalerweise an:</b> wenn die Schaltleiste betätigt wird, schaltet die LED aus</p>
<p><b>Schaltleiste bei der Öffnung:</b></p>	<p><i>In Serie geschaltet bei NC mechanischen Schaltleisten</i></p> <p><i>Parallel geschaltet bei resistiven Schaltleisten 8,2 k<math>\Omega</math></i></p> <p><b>Verwendete Schaltleiste Typ wählen:</b></p> <p>Schaltleiste NC (JA2 gebrückt)</p> <p>Resistive Schaltleiste 8,2 k<math>\Omega</math></p>	<p><b>Normalerweise an:</b> wenn die Schaltleiste betätigt wird, schaltet die LED aus</p>





## ELEKTROANSCHLÜSSE AN DIE KLEMMEN BEI SCHIEBETOR-MODUS - Dip Schalter B Nr.1 = ON

Zubehör	Elektroanschlüsse	Dip-Schalter u. LED-Anzeige der verschiedenen Funktionen
<b>24 Vac Ausgang:</b> 	 24 Vac AUSGANG für max. Belastung: 3 Lichtschranken 1 Funkempfänger 1 LED Schlüsselschalter Chis 37 / Chis-E 37 <i>Alle Anleitungen sind dem entsprechenden Bedienungszubehör beigelegt</i>	
<b>Elektroschloß:</b> 	 12 Vac/dc oder 24 Vac/dc Versorgungsausgang für <b>Elektroschloß</b> 15 VA max  "STRIP" BRÜCKE LOCK SETUP 1 2 3 1 2 3 Stromversorgung für ein mechanisches Elektroschloß  LOCK SETUP 1 2 3 1 2 3 Stromversorgung für ein magnetisches Elektroschloß zum Halten des Tors am Endanschlag  AC = Wechselstrom Ausgang DC = Gleichstrom Ausgang	 <b>ZEIT ELEKTROSCHLOß</b> <b>0,5 s - 20 s</b>   12 V Elektroschloß Stromversorgung   24 V Elektroschloß Stromversorgung
<b>Ausgang für einphasige Motore 230 V - 350 W max - 0,5 PS:</b>	<b>Wenn nur ein Motor angeschlossen ist:</b> 1) Die Stromversorgung an die Klemmen des Motors M1 anschließen 2) Keine Torflügelverzögerung beim Öffnen <b>Dip-A Nr.8 = ON</b> 3) Den Trimmer Torflügelverzögerung beim Schließen auf Null setzen  <b>Wenn 2 Motore angeschlossen sind:</b> 1) Die Stromversorgung an die Klemmen die Motore M1 und M2 anschließen 2) Keine Torflügelverzögerung beim Öffnen <b>Dip-A Nr.8 = ON</b> 3) Den Trimmer Torflügelverzögerung beim Schließen auf Null setzen  	 <b>BETRIEBSZEIT ÖFFNEN-SCHLIEßEN</b> <b>0 s - 120 s</b>   <b>PAUSANZEIT</b> <b>1 s - 220 s</b>
<b>Blinkleuchte 230 Vac:</b> 	   <b>230 Vac AUSGANG</b> für Blinkleuchte max 25 W	<b>DIP-SCHALTER-A Nr.4 u. Nr.10:</b>  <b>ON:</b> Vorblinken bevor der Bewegung  <b>4 OFF:</b> Ohne Vorblinken   <b>ON:</b> Blinkleuchte während der Pause ausgeschaltet. Automatischer Betrieb ( <b>Dip 3 = ON</b> )  <b>10 OFF:</b> Blinkleuchte blinkt während der Pause. Automatischer Betrieb ( <b>Dip 3 = ON</b> )
<b>230 V E-Karte Stromversorgung:</b>	 <b>Steuerung Stromversorgung</b> 230 V - 50/60 Hz ±10% NEUTRAL PHASE	

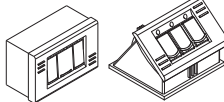
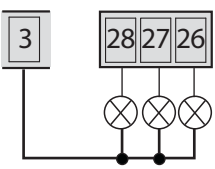

## ELEKTROANSCHLÜSSE AN DIE KLEMMEN BEI SCHIEBETOR-MODUS - Dip Schalter B Nr.1 = ON



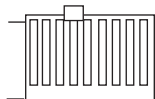

Zubehör	Elektroanschlüsse	LED-Anzeige der verschiedenen Funktionen
<b>LED Anschluss Pulin 3:</b> 	 <p>Klemmen zum Anschluss der LED der Drucktastentafel <b>Pulin 3</b></p>	
<b>24 Vdc - 5 W Ausgang:</b>	 <p>AUSGANG 24 Vdc - 5 W max</p>	

**Einzel-Schiebetor Endschalter:**

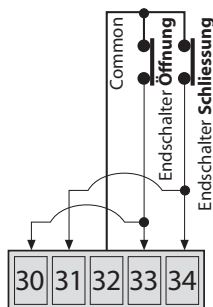
Bei Verwendung von nur einem Motor ist es empfehlenswert, dass die Eingänge der M1 und M2 Endschalter "parallel" geschaltet werden (30 mit 33 und 31 mit 34 überbrücken und sie an die Endschalter Öffnen - Schließen anschliessen).

**WICHTIG:** werden die Endschalter **nicht verwendet**, die Eingänge 30 - 31 - 32 - 33 - 34 überbrücken. Normalerweise geschlossene Fc (Endschalter) verwenden





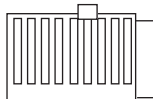
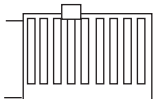

-  **L30 An** = sie erlischt wenn FcA (Endschalter Öffnung) engagiert ist
-  **L31 An** = sie erlischt wenn FcC (Endschalter Schliessung) engagiert ist
-  **L33 An** = sie erlischt wenn FcA (Endschalter Öffnung) engagiert ist
-  **L34 An** = sie erlischt wenn FcC (Endschalter Schliessung) engagiert ist

**Doppel-Schiebetor Endschalter:**

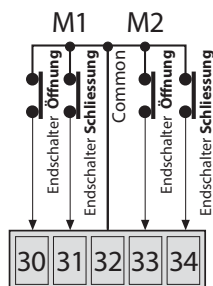
Bei Verwendung von zwei Motoren die Endschalter, normalerweise geschlossen, an die entsprechenden Eingänge anschließen.

**WICHTIG:** werden die Endschalter **nicht verwendet**, die Eingänge 30 - 31 - 32 - 33 - 34 überbrücken. Normalerweise geschlossene Fc (Endschalter) verwenden



-  **L30 An** = sie erlischt wenn FcA (Endschalter Öffnung) M1 engagiert ist
-  **L31 An** = sie erlischt wenn FcC (Endschalter Schliessung) M1 engagiert ist
-  **L33 An** = sie erlischt wenn FcA (Endschalter Öffnung) M2 engagiert ist
-  **L34 An** = sie erlischt wenn FcC (Endschalter Schliessung) M2 engagiert ist

**Ampel-Einsteckplatine (Optional - Art-Nr. 7282L):**

Die Stromversorgung dieser Platine ist unabhängig von deren der elektronischen Steuerung: 230 V - 50 Hz mit 100 W Ausgang zu 230 V jede Leuchte.

**Betriebslogik:**

- **GRÜNES** Licht = Durchfahrt **OFFEN**
- **ROTES** Licht = passaggio **GESCHLOSSEN**
- **GELBES** Licht = Es schaltet ein, bevor das Licht von GRÜN auf ROT schaltet.

**Anmerkung:** Bei **Gehür**-Modus das Ampellicht ist immer **ROT**.

**Dip-Schalter - A**

- 4 = ON** Vorblinken eingeschaltet: Ampellicht rot - gelb - grün
- 4 = OFF** Vorblinken ausgeschaltet: Ampellicht rot - grün

**6 = ON** Endschalter installiert

**6 = OFF** Endschalter überbrückt (Betrieb auf Zeiteinstellung)

**Dip-Schalter - B**

**3 = ON** Vorblinken-Zeit von zirka 2 Sekunden verlängert (das gelbe Licht bis 3 Sekunden)

**3 = OFF** Standard Zeit

**Betrieb mit 2 Leuchten (Rot und Grün):**

- Dip-Schalter - A** **4 = OFF**
- Dip-Schalter - A** **6 =** Die Position einstellen abhängig davon, ob die Endschalter in der Anlage verwendet werden oder nicht

**Dip-Schalter - B** **3 = OFF**

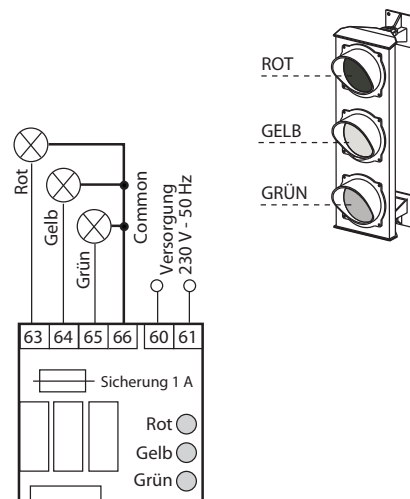

**(Optional:**  
Ampel-Einsteckplatine  
für 230 V Leuchten)  
**Art.Nr. 7282L**

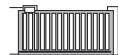

## FUNKTIONEN FÜR DIE ÖFFNUNG DES SCHIEBETORS - Dip Schalter B Nr.1 = ON

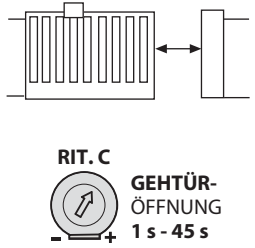
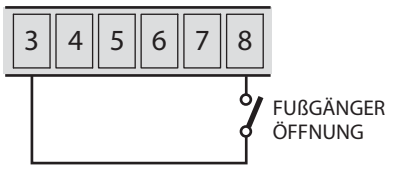
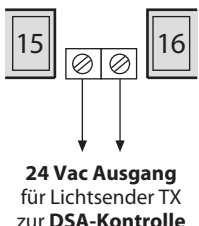
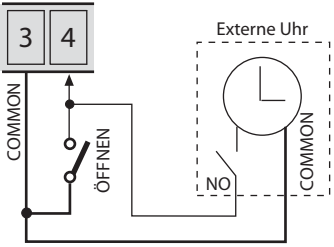
Beschreibung	Dip-Schalter u. LED-Anzeige der verschiedenen Funktionen
<p><b>AUTOMATISCH / HALBAUTOMATISCH:</b>  <b>Automatikzyklus:</b> Das Tor wird auf einen Öffnungsimpuls geöffnet, stoppt während der mit dem <b>Pausen-Trimmer</b> eingestellten Pausenphase und schließt dann wieder automatisch.  <b>Halbautomatischer Zyklus:</b> Das Tor wird auf einen Öffnungsimpuls bis zur Endlage geöffnet und dann stoppt. Zum Schließen muss ein entsprechender Schließimpuls erfolgen.</p>	<p><b>DIP-SCHALTER Nr.3:</b></p> <ul style="list-style-type: none"> <li><input checked="" type="checkbox"/> <b>ON:</b> Automatisches Schliessen</li> <li><input type="checkbox"/> <b>3 OFF:</b> Halbautomatische Funktion</li> </ul> <p> <b>Trimmer Pause:</b> Einstellung der Pausenzeit im Automatikmodus von 1 s bis 220 s</p>
<p><b>GEHTÜRFUNKTION:</b>  Bei geschlossenem Tor ein Öffnungsbefehl an die Klemmen 3-8 geben, um das Tor für die Fußgänger zu öffnen.  (Bei Verwendung der Gehtürfunktion, wird es empfohlen Dip-A Nr. 3 = ON zur automatischen Schliessung zu setzen).  Nach einem Stromausfall ist die Funktion <b>Gehtür-Öffnung</b> für den ersten folgenden Betriebszyklus nicht aktiv.</p> 	<p><input type="checkbox"/> <b>L8 Aus</b> = Kein Fußgänger-Kontakt, sie leuchtet bei jeder Fußgänger-Impuls-gabe</p> 
<p><b>WIEDERSCHLIESSEN NACH DER DURCHFART DER LICHTSCHRANKE:</b>  <b>beim Öffnen und während der Pausenphase (mit DIP-A Nr.3 = ON)</b>  Funktion zum automatischen Schließen nach 3 s nach der Durchfahrt der Lichtschanke. Wird die 2. Lichtschanke verwendet (Dip 9 = ON), müssen beide Lichtschanken durchgefahren werden, um die automatische Wiederschließung zu erhalten.</p>	<p><b>DIP-SCHALTER-A Nr.9 u. Nr.11:</b></p> <ul style="list-style-type: none"> <li><input checked="" type="checkbox"/> <b>ON:</b> 2. Lichtschanke eingeschaltet</li> <li><input type="checkbox"/> <b>9 OFF:</b> 2. Lichtschanke nicht verwendet</li> </ul> <ul style="list-style-type: none"> <li><input checked="" type="checkbox"/> <b>ON:</b> Automatisches Wiederschließen nach der Durchfahrt der Lichtschanke nach 3 Sekunden</li> <li><input type="checkbox"/> <b>11 OFF:</b> Kein automatisches Wiederschließen nach der Durchfahrt der Lichtschanke</li> </ul>
<p><b>DSA: AUTOMATISCHE KONTROLLE DER LICHTSCHRANKEN</b>  Für die DSA-Kontrolle (Device for Safety Auto-test) ist es erforderlich, <b>nur die Lichtsender (TX)</b> an diesen Ausgang anzuschließen und <b>Dip-B Nr.4 = ON:</b> zu setzen: Ist diese Funktion zugeschaltet, wird durch Elpro 27 den einwandfreien Betrieb aller Sicherheitsvorrichtungen vor jeder Torbewegung überprüft, ob kein Hindernis vorhanden ist, sonst wird das Tor nicht geöffnet.</p> 	<p><b>DIP-SCHALTER-B Nr.4:</b></p> <ul style="list-style-type: none"> <li><input checked="" type="checkbox"/> <b>ON:</b> DSA-Kontrolle eingeschaltet</li> <li><input type="checkbox"/> <b>4 OFF:</b> DSA-Kontrolle ausgeschaltet</li> </ul>
<p><b>TOTMANN-BEDIENUNG:</b>  Öffnung- und Schließungs-Bedienung <i>durch gehaltene Betätigung</i> (kein Selbsthalten des Relais), d.h. dass die aktive Anwesenheit des Bedieners während der Automation-Bewegung nötig ist, bis die Taste oder der Schlüssel des Schalters losgelassen wird.</p>	<p><b>DIP-SCHALTER-B Nr.2:</b></p> <ul style="list-style-type: none"> <li><input checked="" type="checkbox"/> <b>ON:</b> Totmann-Bedienung eingeschaltet</li> <li><input type="checkbox"/> <b>2 OFF:</b> Totmann-Bedienung ausgeschaltet</li> </ul>
<p><b>ZULAUF AUTOMATIKFUNKTION</b>  <b>ÖFFNUNG ÜBER EXTERNEN TIMER:</b>  <b>Anschluss:</b> NO-Kontakt des Timers mit Klemmen Nr.4 ÖFFNEN und Nr.3 COMMON anschliessen und das automatische Schließen mit Dip-Schalter Nr.3 = ON freischalten.  <b>Funktionsweise:</b> Öffnungsurzeit am Timer programmieren und das Tor wird zur eingestellten Uhrzeit geöffnet und bleibt offen (Blinkleuchte geht aus). Bis zum Ablauf der eingestellten Uhrzeit ist das Tor für <u>keine weiteren Befehle</u> (auch Funkbefehl) <u>empfänglich</u>, anschließend wird es <u>nach der Pausenzeit automatisch geschlossen</u>.  Während das Tor offen ist, gemäß der auf den <b>Timer</b> eingestellten Pausenzeit, stellt das Anzeigelicht zwei aufeinanderfolgenden Blinken aus, von einer langen Pause gefolgt.</p> 	<p><b>DIP-SCHALTER-A Nr.3:</b></p> <ul style="list-style-type: none"> <li><input checked="" type="checkbox"/> <b>ON:</b> Automatisches Schließen</li> </ul> <p><b>WICHTIG:</b>  <b>Verwenden Sie immer nur mit Dip-A Nr.3 = ON</b></p>



FÜR DREHTORANTRIEBE:  
Dip Schalter B Nr.1 = OFF

## DIP-SCHALTER - B



## Dip-Schalter A

- 1 = ON Lichtschanke stoppt b.Öffnung  
2 = ON Funk.Kein Umkehr b.Öffnung  
3 = ON Automatische Schliessung  
4 = ON Vorblinken aktiv  
5 = ON Funkkontakt. Schrittweise  
6 = ON Service mit Ampel mit  
angeschlossenen Endschaltern

- 7 = ON Schlossentlastung beim Öffnen  
8 = ON Keine Flügelverzögerung beim Öffnen, die Motore laufen  
gleichzeitig an  
9 = ON 2. Lichtschanke angeschlossen  
10 = ON Blinkleuchte aus bei der Pause  
11 = ON Wiederschliessen während der Öffnung und der Pause, wenn die Lichtschanke unterbrochen wird  
12 = ON Zeiteinspeicher aktiv für Installationen mit Hochbetrieb

## DIP-SCHALTER - A



## Dip-Schalter B

- 1 = OFF SCHIEBETORANTRIEB Modus  
2 = ON Totmann-Betrieb  
3 = ON Ampel auf "gelb" 3 Sekunden lang  
4 = ON DSA Kontrolle durch die Lichtsender, wenn sie an die dedizierten Klemmen angeschlossen sind

## DIP-SCHALTER - B



## ELEKTROANSCHLÜSSE AN DIE KLEMMEN BEI DREHTOR-MODUS - Dip Schalter B Nr.1 = OFF

Zubehör	Elektroanschlüsse	Dip-Schalter u. LED-Anzeige der verschiedenen Funktionen
<b>2. Lichtschanke (innerlich montiert):</b> 	<p>Diese Lichtschanke stoppt während der Öffnung; nach Entfernung des Hindernisses öffnet das Tor weiter, beim Schliessen kehrt das Tor um.</p> <p><b>Dip-A Nr.9 = ON und der NC Ausgang angeschlossen:</b> das Torbleibt stehen solange die Lichtschanke engagiert ist. - Beim Öffnen: nach Entfernung des Hindernisses öffnet das Tor weiter - Beim Schließen: nach Entfernung des Hindernisses kehrt das Tor um <b>HINWEIS: den Kontakt-Eingang nicht überbrücken, wenn keine 2.Lichtschanke vorhanden ist, nur Dip-A Nr. 9 = OFF lassen</b></p>	<b>DIP-SCHALTER-A Nr. 9:</b> <input checked="" type="checkbox"/> ON: 2. Lichtschanke im Service <input type="checkbox"/> OFF: 2. Lichtschanke nicht verwendet  <input checked="" type="checkbox"/> L0 An = kein Hindernis vorhanden; sie erlischt bei vorhandenem Hindernis
<b>1. Lichtschanke (äusserlich montiert):</b> 	<p><b>Ausgang 24 Vac max Belastung:</b> 1 Funkempfänger 3 Lichtschranken</p> <p>Alle NC-Kontakte des Sicherheitszubehörs, wie Lichtschanke (Lichtempfänger), müssen an die Klemmen 1 und 2 in Seriegeschaltet werden</p>	<b>DIP-SCHALTER-A Nr. 1:</b> <input checked="" type="checkbox"/> ON: sie stoppt während der Öffnung und kehrt bei Schliessung nach Entfernung des Hindernisses um <input type="checkbox"/> OFF: sie stoppt nicht während der Öffnung und kehrt bei Schliessung bei vorhandenem Hindernis um  <input checked="" type="checkbox"/> L1 An = kein Hindernis vorhanden; sie erlischt bei vorhandenem Hindernis
<b>Schlüsselschalter:</b> 	<p>NO und NC - Kontakte an die entsprechenden Klemmen der Schlüsselschalter oder der Drucktaster anzuschliessen. Die mögliche Konfigurationen sind den jeweiligen Bedienungszubehör beigelegt.</p>	<input type="checkbox"/> L4 Aus = kein Kontakt ÖFFNUNG, sie leuchtet bei jeder Öffnungsimpuls-gabe <input type="checkbox"/> L5 Aus = kein Kontakt SCHLIESSUNG, sie leuchtet bei jeder Schliessungskontakt <input checked="" type="checkbox"/> L6 An = STOP-Kontakt geschlossen, sie erlischt bei jeder Stop-Impuls-gabe
<b>Funkkontakt (bei schrittweiser Funktion):</b> 	<p>Wird jeder beliebige NO Kontakt zwischen der zwei Klemmen angeschlossen, ist folgendes bei jeder Impuls-gabe möglich: - Nur Öffnung: <b>dip 2 = ON u. dip 5 = OFF</b> - Richtungsumkehr bei jeder Impuls-gabe <b>dip 2 = OFF u. dip 5 = OFF</b> - Schrittweise: Öffnen-Stop-Schliessen-Stop <b>dip 2 = OFF u. dip 5 = ON</b> - Während der Öffnung wird kein Befehl akzeptiert. Bei der Pause und beim Schliessen jede Impuls-gabe stoppt und kehrt die Laufrichtung um: <b>dip 2 = ON u. dip 5 = ON</b></p>	<b>DIP-SCHALTER-A Nr. 2 u. Nr. 5:</b> <input checked="" type="checkbox"/> ON: Kein Umkehr und kein Stop beim Öffnen <input type="checkbox"/> 2 OFF: Sie stoppt und kehrt immer beim Öffnen um <input checked="" type="checkbox"/> ON: Schrittweise-Funktion mit Zwischenhalten <input type="checkbox"/> 5 OFF: Sie kehrt den Lauf bei jeder Impuls-gabe um <input type="checkbox"/> L7 Aus = kein FUNKkontakt, sie leuchtet bei jeder Funkimpuls-gabe
<b>Anzeigelicht Ausgang 24 V - max 3 W:</b>	<p>Ausgang für ein eventuelles Anzeigelicht 24 V max 3 W des Automation-Status: Licht An = offenes Tor Licht Aus = geschlossenes Tor Blinken 0,5 s (schnell) = Schliessbewegung Blinken 1 s (standard) = Öffnungsbewegung</p>	



## SCHALTLEISTEN

Die zwei Eingänge, vorgesehen zum Anschluß der Schaltleisten, sind für die Öffnungs- und Schließungsphase getrennt. Außerdem kann man die Art des angeschlossenen Kontakts auswählen, entweder mechanisch NC oder resistiv 8,2 kΩ mittels der zwei Überbrückungen JA1 und JA2. Dank einer dedizierten Mikrokontroller, auf der Karte eingesteckt, wird die tatsächliche Integrität und perfekte Funktionalität des Sicherheitssystems ständig überwacht. Eventuelle Fehler oder Effizienzverlust werden durch Blinken der L10 und L35 LEDs signalisiert.

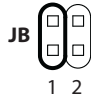
**Betriebseinsetzung:**

Sie kehrt für eine kurze Strecke beim Öffnen und Schliessen um.

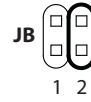

Nach Freilassen des Hindernisses infolge des Eingriffs der Schaltleiste schliesst das Tor automatisch (Wenn automatisches Schliessen Modus gesetzt wurde).

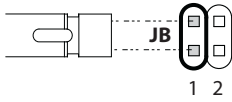

Sie kehrt für eine doppelte Strecke beim Öffnen und Schliessen um.

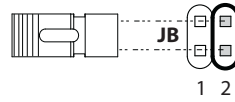

Nach Freilassen des Hindernisses infolge des Eingriffs der Schaltleiste bleibt das Tor bis zur neuen Impuls-gabe stehen (Auch wenn automatisches Schliessen Modus gesetzt wurde).

(JB1 gebrückt)

(JB2 gebrückt)

Zubehör	Elektroanschlüsse	LED-Anzeige der verschiedenen Funktionen
<p><b>Schaltleiste bei der Schließung:</b></p>	<p><i>In Serie geschaltet bei NC mechanischen Schaltleisten</i></p> <p><i>Parallel geschaltet bei resistiven Schaltleisten 8,2 kΩ</i></p> <p><b>Verwendete Schaltleiste Typ wählen:</b></p> <p>Schaltleiste NC (JA1 gebrückt)</p> <p>Resistive Schaltleiste 8,2 kΩ</p>	<p> <b>Normalerweise an:</b> wenn die Schaltleiste betätigt wird, schaltet die LED aus</p>
<p><b>Schaltleiste bei der Öffnung:</b></p>	<p><i>In Serie geschaltet bei NC mechanischen Schaltleisten</i></p> <p><i>Parallel geschaltet bei resistiven Schaltleisten 8,2 kΩ</i></p> <p><b>Verwendete Schaltleiste Typ wählen:</b></p> <p>Schaltleiste NC (JA2 gebrückt)</p> <p>Resistive Schaltleiste 8,2 kΩ</p>	<p> <b>Normalerweise an:</b> wenn die Schaltleiste betätigt wird, schaltet die LED aus</p>







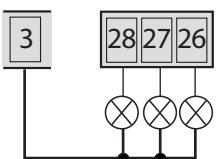

## ELEKTROANSCHLÜSSE AN DIE KLEMMEN BEI DREHTOR-MODUS - Dip Schalter B Nr.1 = OFF

Zubehör	Elektroanschlüsse	Dip-Schalter u. LED-Anzeige der verschiedenen Funktionen
<b>24 Vac Ausgang:</b> 	<p>24 Vac AUSGANG für max. Belastung: 3 Lichtschranken 1 Funkempfänger 1 LED Schlüsselschalter Chis 37 / Chis-E 37 <i>Alle Anleitungen sind dem entsprechenden Bedienungszubehör beigelegt</i></p>	
<b>Elektroschloß:</b> 	<p>12 Vac/dc oder 24 Vac/dc Versorgungsausgang für <b>Elektroschloß</b> 15 VA max. Das Elektroschloß ist auf den Torflügel zu montieren, der durch Motor M1 betrieben und beim Schließen verzögert ist.</p> <p>"STRIP" BRÜCKE</p> <p>LOCK SETUP 3 2 1       Stromversorgung für ein mechanisches Elektroschloß</p> <p>LOCK SETUP 3 2 1       Stromversorgung für ein magnetisches Elektroschloß zum Halten des Tors am Endanschlag</p> <p>AC       = Wechselstrom Ausgang</p> <p>DC       = Gleichstrom Ausgang</p>	<b>ZEIT ELEKTROSCHLOß</b> 0,5 s - 20 s
<b>Ausgang für einphasige Motore 230 V - 350 W max - 0,5 PS:</b>	<p><b>Wenn nur ein Motor angeschlossen ist:</b></p> <ol style="list-style-type: none"> <li>1) Die Stromversorgung an die Klemmen des Motors M1 anschließen</li> <li>2) Keine Torflügelverzögerung beim Öffnen <b>Dip-A Nr.8 = ON</b></li> <li>3) Den Trimmer Torflügelverzögerung beim Schließen auf Null setzen</li> </ol> <p><b>Wenn 2 Motore angeschlossen sind:</b></p> <p>Torflügelverzögerung beim Öffnen, mit fester Zeit von 2 s: wenn erforderlich, sie muss durch <b>Dip-A Nr.8 = OFF</b> aktiviert werden</p> <p>Motor beim Schließen verzögert</p> <p>Motor beim Öffnen verzögert</p>	<b>BETRIEBSZEIT ÖFFNEN-SCHLIEßEN</b> 0 s - 60 s
		<b>PAUSENZEIT</b> 1 s - 220 s
		<b>TORFLÜGEL-VERZÖGERUNG SCHLIEßUNG</b> 0 s - 10 s
		<b>DIP-SCHALTER-A Nr.8:</b> <ul style="list-style-type: none"> <li><input type="checkbox"/> ON: Kein Torflügelverzögerung beim Öffnen</li> <li><input type="checkbox"/> 8 OFF: Torflügelverzögerung von 2 s beim Öffnen aktiviert</li> </ul>
<b>Elektroverriegelung u. Blinkleuchte 230 Vac:</b> 	<p>USCITA 230 Vac per elettrocatenaccio: <b>è importante sempre togliere alimentazione durante la pausa con dip-A n° 10 = ON</b></p> <p>230 Vac AUSGANG für Blinkleuchte max 25 W</p>	<b>DIP-SCHALTER-A Nr.4 u. Nr.10:</b> <ul style="list-style-type: none"> <li><input type="checkbox"/> ON: Vorblinken bevor der Bewegung</li> <li><input type="checkbox"/> 4 OFF: Ohne Vorblinken</li> </ul> <ul style="list-style-type: none"> <li><input type="checkbox"/> ON: Ausgeschaltet während der Pause. Automatischer Betrieb (<b>Dip 3 = ON</b>)</li> <li><input type="checkbox"/> 10 OFF: Gespeist d.h. im Betrieb während der Pause. Automatischer Betrieb (<b>Dip 3 = ON</b>)</li> </ul>
<b>230V E-Karte Stromversorgung:</b>	<p>Steuerung Stromversorgung 230 V - 50/60 Hz ± 10%</p>	

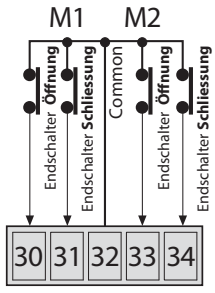

## FUNKTIONEN FÜR DIE ÖFFNUNG DES DREHTOR-MODUS - Dip Schalter B Nr.1 = OFF

Zubehör	Elektroanschlüsse	LED-Anzeige der verschiedenen Funktionen
<b>LED Anschluß Pulin 3:</b> 	Klemmen zum Anschluß der LED der Drucktastentafel <b>Pulin 3</b>	
<b>24 Vdc - 5 W Ausgang:</b> 	24 Vdc - 5 W max AUSGANG	
<b>Endschalter:</b>	<b>WICHTIG:</b> werden die Endschalter <b>nicht verwendet</b> , die Eingänge 30 - 31 - 32 - 33 - 34 überbrücken. Normalerweise geschlossene Fc (Endschalter) verwenden  	 <b>L30 An</b> = sie erlischt wenn FcA (Endschalter Öffnung) M1 engagiert ist  <b>L31 An</b> = sie erlischt wenn FcC (Endschalter Schliessung) M1 engagiert ist  <b>L33 An</b> = sie erlischt wenn FcA (Endschalter Öffnung) M2 engagiert ist  <b>L34 An</b> = sie erlischt wenn FcC (Endschalter Schliessung) M2 engagiert ist

**Ampel-Einsteckplatine (Optional - Art-Nr. 7282L):**

Die Stromversorgung dieser Platine ist unabhängig von deren der elektronischen Steuerung: 230 V - 50 Hz mit 100 W Ausgang zu 230 V jede Leuchte.

**Betriebslogik:**

- **GRÜNES** Licht = Durchfahrt **OFFEN**
- **ROTES** Licht = passaggio **GESCHLOSSEN**
- **GELBES** Licht = Es schaltet ein, bevor das Licht von GRÜN auf ROT schaltet.

**Anmerkung:** Bei **Gehür**-Modus das Ampellicht ist immer **ROT**.

**Dip-Schalter - A**

- 4 = ON** Vorblinken eingeschaltet: Ampellicht rot - gelb - grün
- 4 = OFF** Vorblinken ausgeschaltet: Ampellicht rot - grün

**6 = ON** Endschalter installiert

**6 = OFF** Endschalter überbrückt (Betrieb auf Zeiteinstellung)

**Dip-Schalter - B**

**3 = ON** Vorblinken-Zeit von zirka 2 Sekunden verlängert (das gelbe Licht bis 3 Sekunden)

**3 = OFF** Standard Zeit

**Betrieb mit 2 Leuchten (Rot und Grün):**

**Dip-Schalter - A**     **4 = OFF**

**Dip-Schalter - A**     **6 =** Die Position einstellen abhängig davon, ob die Endschalter in der Anlage verwendet werden oder nicht

**Dip-Schalter - B**     **3 = OFF**

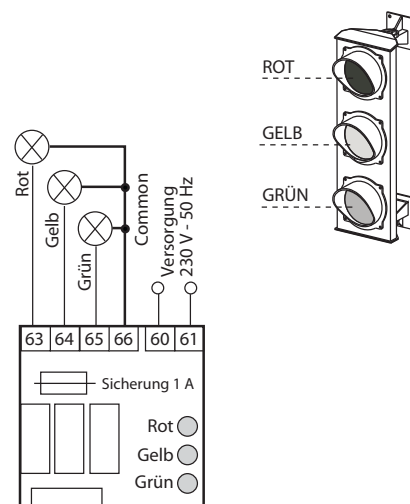
**(Optional):**

Ampel-Einsteckplatine für 230 V Leuchten)  
Art.Nr. **7282L**



## FUNKTIONEN FÜR DIE ÖFFNUNG DES DREHTOR-MODUS - Dip Schalter B Nr.1 = OFF

Beschreibung

Dip-Schalter u. LED-Anzeige der verschiedenen Funktionen

**AUTOMATISCH / HALBAUTOMATISCH:****Automatikzyklus:** Das Tor wird auf einen Öffnungsimpuls geöffnet, stoppt während der mit dem **Pausen-Trimmer** eingestellten Pausenphase und schließt dann wieder automatisch.**Halbautomatischer Zyklus:** Das Tor wird auf einen Öffnungsimpuls bis zur Endlage geöffnet und dann stoppt. Zum Schließen muss ein entsprechender Schließimpuls erfolgen.**DIP-SCHALTER Nr.3:**

- ON:** Automatisches Schliessen
- 3 OFF:** Halbautomatische Funktion

**Trimmer Pause:** Einstellung der Pausenzeit im Automatikmodus von 1 s bis 220 s**GEHTÜRFUNKTION NUR FÜR DEN MOTOR M1:**

Bei geschlossenem Tor ein Öffnungsbefehl an die Klemmen 3-8 geben, um das Tor für die Fußgänger zu öffnen.

(Bei Verwendung der Gehtürfunktion, wird es empfohlen Dip-A Nr. 3 = ON zur automatischen Schließung zu setzen).

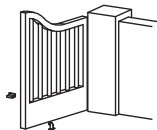
Nach einem Stromausfall ist die Funktion **Gehtür-Öffnung** für den ersten folgenden Betriebszyklus nicht aktiv.

- L8 Aus =** Kein Fußgänger-Kontakt, sie leuchtet bei jeder Fußgänger-Impulsgabe

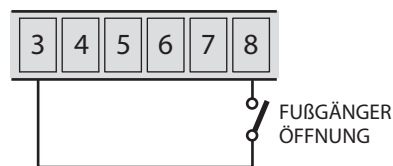
**WIEDERSCHLIESSEN NACH DER DURCHFART DER LICHTSCHRANKE:****beim Öffnen und während der Pausenphase (mit DIP-A Nr.3 = ON)**

Funktion zum automatischen Schließen nach 3 s nach der Durchfahrt der Lichtschanke. Wird die 2. Lichtschanke verwendet (Dip 9 = ON), müssen beide Lichtschanken durchgefahren werden, um die automatische Wiederschließung zu erhalten.

**DIP-SCHALTER-A Nr.9 u. Nr.11:**

- ON:** 2. Lichtschanke eingeschaltet
- 9 OFF:** 2. Lichtschanke nicht verwendet

- ON:** Automatisches Wiederschließen nach der Durchfahrt der Lichtschanke nach 3 Sekunden
- 11 OFF:** Kein automatisches Wiederschließen nach der Durchfahrt der Lichtschanke

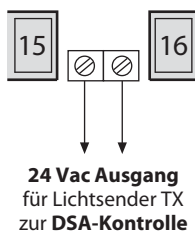
**DSA: AUTOMATISCHE KONTROLLE DER LICHTSCHRANKEN**Für die **DSA-Kontrolle (Device for Safety Auto-test)** ist es erforderlich, **nur die Lichtsender (TX)** an diesen Ausgang anzuschließen und **Dip-B Nr.4 = ON:** zu setzen. Ist diese Funktion zugeschaltet, wird durch Elpro 27 den einwandfreien Betrieb aller Sicherheitsvorrichtungen vor jeder Torbewegung überprüft, ob kein Hindernis vorhanden ist, sonst wird das Tor nicht geöffnet.**DIP-SCHALTER-B Nr.4:**

- ON:** DSA-Kontrolle eingeschaltet
- 4 OFF:** DSA-Kontrolle ausgeschaltet

**TOTMANN-BEDIENUNG:**Öffnung- und Schließungs-Bedienung *durch gehaltene Betätigung* (kein Selbsthalten des Relais), d.h. dass die aktive Anwesenheit des Bediener während der Automation-Bewegung nötig ist, bis die Taste oder der Schlüssel des Schalters losgelassen wird.**DIP-SCHALTER-B Nr.2:**

- ON:** Totmann-Bedienung eingeschaltet
- 2 OFF:** Totmann-Bedienung ausgeschaltet

**SCHLOSSENTLASTUNG BEI DER ÖFFNUNG:**Diese Funktion hilft das Elektroschloß zur Entsperrung des geschlossenen Tors, auch bei *Fußgänger Modus*: Die Torflügel in der geschlossenen Position werden für **2 Sekunden** in der Schliessrichtung gedrückt, bevor das Öffnungszyklus beginnt.**DIP-SCHALTER-A Nr.7:**

- ON:** Schloßentlastung beim Öffnen für 2 s eingeschaltet
- 7 OFF:** Schloßentlastung ausgeschaltet

**ANWENDUNG BEI EIGENTUMSWOHNUNG:**

Diese ist eine Funktion für intensiven Betrieb Anwendungen mit häufigen Richtungsumkehrungen: Diese Funktion, wenn eingeschaltet, berücksichtigt die Restzeit der Torlaufes, wenn der Richtungsumkehr oder die Durchfahrt der Lichtschanke erfolgt.

**DIP-SCHALTER-A Nr.12:**

- ON:** Speicher der Laufzeit eingeschaltet
- 12 OFF:** Normale Funktion ohne Speicher

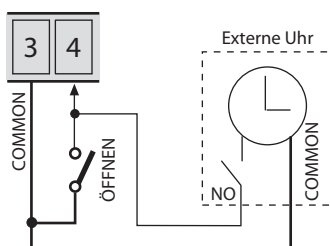
**ZULAUF AUTOMATIKFUNKTION****ÖFFNUNG ÜBER EXTERNEN TIMER:****Anschluss:** NO-Kontakt des Timers mit Klemmen Nr.4 ÖFFNEN und Nr.3 COMMON anschließen und das automatische Schließen mit Dip-Schalter Nr.3 = ON freischalten.**Funktionsweise:** Öffnungsurzeit am Timer programmieren und das Tor wird zur eingestellten Uhrzeit geöffnet und bleibt offen (Blinkleuchte geht aus). Bis zum Ablauf der eingestellten Uhrzeit ist das Tor für keine weiteren Befehle (auch Funkbefehl) empfänglich, anschließend wird es nach der Pausenzeit automatisch geschlossen.Während das Tor offen ist, gemäß der auf den **Timer** eingestellten Pausenzeit, stellt das Anzeigelicht zwei aufeinanderfolgenden Blinken aus, von einer langen Pause gefolgt.**DIP-SCHALTER-A Nr.3:**

- ON:** Automatisches Schließen
- 3**

**WICHTIG:****Verwenden Sie immer nur mit Dip-A Nr.3 = ON**







IT DATI TECNICI	
Alimentazione scheda monofase	230 Vac ±10% 50/60 Hz
Alimentazione scheda trifase	-
Potenza max. motori	750 W
Uscita luce di cortesia	230 Vac - 100 W
Uscita fotocellule/selettore/radio ricevente	24 Vac
Uscita spia di segnalazione	24 Vac - 3 W
Uscita per controllo DSA	24 Vac - 150 mA
Uscita lampeggiante	230 Vac - 25 W
Tempo di lavoro	0 - 120 s (scorrevole) 0 - 60 s (battente)
Tempo di pausa	1 - 220 s
Tempo ritardo anta in chiusura	0 - 10 s
Tempo apertura pedonale	1 - 45 s
Dimensioni contenitore	210x295x110 mm
Grado di protezione	IP 64
Temperatura di esercizio	-20 °C +55 °C

GB TECHNICAL SPECIFICATIONS	
Single-phase PCB power supply	230 Vac ±10% 50/60 Hz
Three-phase PCB power supply	-
Max. power of motors	750 W
Courtesy light output	230 Vac - 100 W
Photocells/keyswitch/radio receiver output	24 Vac
Pilot light output	24 Vac - 3 W
DSA control output	24 Vac - 150 mA
Flasher output	230 Vac - 25 W
Motor run time	0 - 120 s (sliding) 0 - 60 s (swinging)
Dwell time	1 - 220 s
Closing gate delay time	0 - 10 s
Pedestrian opening time	1 - 45 s
Box dimensions	210x295x110 mm
Protection standards	IP 64
Working temperature	-20 °C +55 °C

FR CARACTERISTIQUES TECHNIQUES	
Alimentation carte monophasée	230 Vac ±10% 50/60 Hz
Alimentation carte triphasée	-
Puissance max. moteurs	750 W
Sortie lumière de courtoisie	230 Vac - 100 W
Sortie photocellules/sélecteur/récepteur radio	24 Vac
Sortie voyant de signalisation	24 Vac - 3 W
Sortie pour contrôle DSA	24 Vac - 150 mA
Sortie lampe clignotante	230 Vac - 25 W
Temps de travail	0 - 120 s (coulissant) 0 - 60 s (à battant)
Temps de pause	1 - 220 s
Temps de retard vantail à la fermeture	0 - 10 s
Temps d'ouverture piétons	1 - 45 s
Dimensions boîte	210x295x110 mm
Degré de protection	IP 64
Température de service	-20 °C +55 °C

DE TECHNISCHE DATEN	
Einphasige Karte Stromversorgung	230 Vac ±10% 50/60 Hz
Dreiphasige Karte Stromversorgung	-
Max. Leistung von Motoren	750 W
Courtesy Licht Ausgang	230 Vac - 100 W
Lichtschranken/Schlussschalter/Empfänger Ausgang	24 Vac
Anzeigelicht Ausgang	24 Vac - 3 W
DSA Steuerausgang	24 Vac - 150 mA
Blinkleuchte Ausgang	230 Vac - 25 W
Motorlaufzeit	0 - 120 s (Schiebetor) 0 - 60 s (Drehtor)
Pausezeit	1 - 220 s
Torflügelverzögerung beim Schließen	0 - 10 s
Fußgänger Öffnungszeit	1 - 45 s
Kastenmaße	210x295x110 mm
Schutzgrad	IP 64
Betriebstemperatur	-20 °C +55 °C

